

Appliance Parts Catalog



Backer EHP

4700 John Bragg Highway

Murfreesboro, TN 37127

(615) 907-6900

<http://www.backerehp.com>



Backer

Catalog # DA-707



Backer EHP

TERMS AND CONDITIONS OF SALE

Backer EHP is herein referred to as the "Seller" and the customer or person or entity purchasing goods ("Goods") from Seller is referred to as the "Buyer." These Terms and Conditions, any price list or schedule, quotation, acknowledgment or invoice from Seller relevant to the sale of the Goods and all documents incorporated by specific reference herein or therein, constitute the complete and exclusive statement of the terms of the agreement governing the sale of Goods by Seller to Buyer. **Seller's acceptance of Buyer's purchase order is expressly conditional on Buyer's assent to all of Seller's terms and conditions of sale, including terms and conditions that are different from or additional to the terms and conditions of Buyer's purchase order.** Buyer's acceptance of or payment for the Goods will manifest Buyer's assent to these Terms and Conditions. Seller reserves the right in its sole discretion to refuse orders.

1. **PRICES:** Prices for Goods, whether specified in Seller's price list or schedule, acknowledgment or written quotation, are subject to change without notice. Such prices shall be adjusted to reflect Seller's prices for Goods as in effect at the time of requested shipment date, and each shipment will be invoiced at such prices. All prices are exclusive of taxes, transportation and insurance, which are to be borne by Buyer.

2. **TAXES:** Any current or future tax or governmental charge (or increase in same) affecting Seller's costs of production, sale, or delivery or shipment, or which Seller is otherwise required to pay or collect in connection with the sale, purchase, delivery, storage, processing, use or consumption of Goods, shall be for Buyer's account and shall be added to the price or billed to Buyer separately, at Seller's election.

3. **TERMS OF PAYMENT:** Unless otherwise specified by Seller, terms are net thirty (30) days from date of Seller's invoice in U.S. currency. Seller shall have the right, among other remedies, either to terminate this agreement or to suspend further performance under this and/or other agreements with Buyer in the event Buyer fails to make any payment when due, which other agreements Buyer and Seller hereby amend accordingly. Buyer shall be liable for all expenses, including attorneys' fees, relating to the collection of past due amounts. If any payment owed to Seller is not paid when due, it shall bear interest, at a rate to be determined by Seller, which shall not exceed the maximum rate permitted by law, from the date on which it is due until it is paid. Should Buyer's financial responsibility become unsatisfactory to Seller, cash payments or security satisfactory to Seller may be required by Seller for future deliveries and for the Goods theretofore delivered. If such cash payment or security is not provided, in addition to Seller's other rights and remedies, Seller may discontinue deliveries. Buyer hereby grants Seller a security interest in all Goods sold to Buyer by Seller, which security interest shall continue until all such Goods are fully paid for in cash, and Buyer, upon Seller's demand, will execute and deliver to Seller such instruments as Seller requests to protect and perfect such security interest.

4. **SHIPMENT AND DELIVERY:** While Seller will use all reasonable commercial efforts to maintain the delivery date(s) acknowledged or quoted by Seller, all shipping dates are approximate and not guaranteed. Seller reserves the right to make partial shipments. Seller, at its option, shall not be bound to tender delivery of any Goods for which Buyer has not provided shipping instructions and other required information. If the shipment of the Goods is postponed or delayed by Buyer for any reason, Buyer agrees to reimburse Seller for any and all storage costs and other additional expenses resulting therefrom. Risk of loss and legal title to the Goods shall transfer to Buyer for sales in which the end destination of the Goods is outside of the United States immediately after the Goods have passed beyond the territorial limits of the United States. For all other shipments, risk of loss for damage and responsibility shall pass from Seller to Buyer upon delivery to and receipt by carrier at Seller's shipping point. All shipments are F.O.B. Seller's shipping point. Any claims for shortages or damages suffered in transit are the responsibility of Buyer and shall be submitted by Buyer directly to the carrier. Shortages or damages must be identified and signed for at the time of delivery.

5. **LIMITED WARRANTY:** Subject to the limitations of Section 6, Seller warrants that the Goods manufactured by Seller will be free from defects in material and workmanship and meet Seller's published specifications at the time of shipment under normal use and regular service and maintenance for a period of one year from the date of shipment of the Goods by Seller, unless otherwise specified by Seller in writing. Products purchased by Seller from a third party for resale to Buyer ("Resale Products") shall carry only the warranty extended by the original manufacturer. **THE WARRANTY SET FORTH IN THIS SECTION 5 AND THE WARRANTY SET FORTH IN SECTION 7, ARE THE SOLE AND EXCLUSIVE WARRANTIES GIVEN BY SELLER WITH RESPECT TO THE GOODS AND ARE IN LIEU OF AND EXCLUDE ALL OTHER WARRANTIES, EXPRESS OR IMPLIED, ARISING BY OPERATION OF LAW OR OTHERWISE, INCLUDING WITHOUT LIMITATION, MERCHANTABILITY AND FITNESS FOR A PARTICULAR PURPOSE WHETHER OR NOT THE PURPOSE OR USE HAS BEEN DISCLOSED TO SELLER IN SPECIFICATIONS, DRAWINGS OR OTHERWISE, AND WHETHER OR NOT SELLER'S PRODUCTS ARE SPECIFICALLY DESIGNED AND/OR MANUFACTURED BY SELLER FOR BUYER'S USE OR PURPOSE.**

This warranty does not extend to any losses or damages due to misuse, accident, abuse, neglect, normal wear and tear, negligence (other than Seller's), unauthorized modification or alteration, use beyond rated capacity, unsuitable power sources or environmental conditions, improper installation, repair, handling, maintenance or application or any other cause not the fault of Seller. To the extent that Buyer or its agents has supplied specifications, information, representation of operating conditions or other data to Seller in the selection or design of the Goods and the preparation of Seller's quotation, and in the event that actual operating conditions or other conditions differ from those represented by Buyer, any warranties or other provisions contained herein which are affected by such conditions shall be null and void.

If within thirty (30) days after Buyer's discovery of any warranty defects within the warranty period, Buyer notifies Seller thereof in writing, Seller shall, at its option and as Buyer's exclusive remedy, repair, correct or replace or refund the purchase price for, that portion of the Goods found by Seller to be defective. Failure by Buyer to give such written notice within the applicable time period shall be deemed an absolute and unconditional waiver of Buyer's claim for such defects. Seller shall have the right to require the Buyer to deliver the Goods to Seller's designated repair center or manufacturing facility. All costs associated with dismantling, reinstallation and transportation to and from Seller's designated repair center or manufacturing facility and the time and expense of Seller's personnel and representatives for site travel and diagnosis under this warranty shall be borne by the Buyer. Goods repaired or replaced during the warranty period shall be covered by the foregoing warranty for the remainder of the original warranty period or ninety (90) days from the date of shipment, whichever is longer. Buyer assumes all other responsibility for any loss, damage, or injury to persons or property arising out of, connected with, or resulting from the use of Goods, either alone or in combination with other products/components.

Section 5 applies to any entity or person who may buy, acquire or use the Goods, including any entity or person who obtains the Goods from Buyer, and shall be bound by the limitations therein, including Section 6. Buyer agrees to provide such subsequent transferee conspicuous, written notice of the provisions of Sections 5 and 6.

6. **LIMITATION OF REMEDY AND LIABILITY:** THE SOLE AND EXCLUSIVE REMEDY FOR BREACH OF ANY WARRANTY HEREUNDER (OTHER THAN THE WARRANTY PROVIDED UNDER SECTION 7) SHALL BE LIMITED TO REPAIR, CORRECTION OR REPLACEMENT, OR REFUND OF THE PURCHASE PRICE UNDER SECTION 5.

SELLER SHALL NOT BE LIABLE FOR DAMAGES CAUSED BY DELAY IN PERFORMANCE AND THE REMEDIES OF BUYER SET FORTH IN THIS AGREEMENT ARE EXCLUSIVE. IN NO EVENT, REGARDLESS OF THE FORM OF THE CLAIM OR CAUSE OF ACTION (WHETHER BASED IN CONTRACT, INFRINGEMENT, NEGLIGENCE, STRICT LIABILITY, OTHER TORT OR OTHERWISE), SHALL SELLER'S LIABILITY TO BUYER AND/OR ITS CUSTOMERS EXCEED THE PRICE PAID BY BUYER FOR THE SPECIFIC GOODS PROVIDED BY SELLER GIVING RISE TO THE CLAIM OR CAUSE OF ACTION. BUYER AGREES THAT IN NO EVENT SHALL SELLER'S LIABILITY TO BUYER AND/OR ITS CUSTOMERS EXTEND TO INCLUDE INCIDENTAL, CONSEQUENTIAL OR PUNITIVE DAMAGES. The term "consequential damages" shall include, but not be limited to, loss of anticipated profits, business interruption, loss of use, revenue, reputation and data, costs incurred, including without limitation, for capital, fuel, power and loss or damage to property or equipment.

It is expressly understood that any technical advice furnished by Seller with respect to the use of the Goods is given without charge, and Seller assumes no obligation or liability for the advice given, or results obtained, all such advice being given and accepted at Buyer's risk.

7. **PATENTS AND COPYRIGHTS:** Subject to the limitations of the second paragraph of Section 6, Seller warrants that the Goods sold, except as are made specifically for Buyer according to Buyer's specifications, do not infringe any valid U.S. patent or copyright in existence as of the date of shipment. This warranty is given upon the condition that Buyer promptly notifies Seller of any claim or suit involving Buyer in which such infringement is alleged and cooperates fully with Seller and permit Seller to control completely the defense, settlement or compromise of any such allegation of infringement. Seller's warranty as to use patents only applies to infringement arising solely out of the inherent operation according to Seller's specifications and instructions (i) of such Goods, or (ii) of any combination of Goods acquired from Seller in a system designed by Seller. In the event such Goods are held to infringe such a U.S. patent or copyright in such suit, and the use of such Goods is enjoined, or in the case of a compromise or settlement by Seller, Seller shall have the right, at its option and expense, to procure for Buyer the right to continue using such Goods, or replace them with non-infringing Goods, or modify same to become non-

infringing, or grant Buyer a credit for the depreciated value of such Goods and accept return of them. In the event of the foregoing, Seller may also, at its option, cancel the agreement as to future deliveries of such Goods, without liability. No license or rights in any of Seller's intellectual property associated with the Goods is granted hereon.

8. **EXCUSE OF PERFORMANCE:** Seller shall not be liable for delays in performance or for non-performance due to acts of God; acts of Buyer; war; fire; flood; weather; sabotage; strikes or labor disputes; civil disturbances or riots; governmental requests, restrictions, allocations, laws, regulations, orders or actions; unavailability of or delays in transportation; default of suppliers; or unforeseen circumstances or any events or causes beyond Seller's reasonable control. Deliveries or other performance may be suspended for an appropriate period of time or canceled by Seller upon notice to Buyer in the event of any of the foregoing, but the balance of the agreement shall otherwise remain unaffected as a result of the foregoing.

If Seller determines that its ability to supply the total demand for the Goods, or to obtain material used directly or indirectly in the manufacture of the Goods, is hindered, limited or made impracticable due to causes set forth in the preceding paragraph, Seller may allocate its available supply of the Goods or such material (without obligation to acquire other supplies of any such Goods or material) among itself and its purchasers on such basis as Seller determines to be equitable without liability for any failure of performance which may result therefrom.

9. **CANCELLATION:** Buyer may cancel orders only upon reasonable advance written notice and upon payment to Seller of Seller's cancellation charges which include, among other things, all costs and expenses incurred, and, to cover commitments made, by the Seller and a reasonable profit thereon. Seller's determination of such termination charges shall be conclusive.

10. **CHANGES:** Buyer may request changes or additions to the Goods consistent with Seller's specifications and criteria. In the event such changes or additions are accepted by Seller, Seller may revise the price and dates of delivery. Seller reserves the right to change designs and specifications for the Goods without prior notice to Buyer, except with respect to Goods being made-to-order for Buyer. Seller shall have no obligation to install or make such change in any Goods manufactured prior to the date of such change.

11. **NUCLEAR/MEDICAL:** GOODS SOLD HEREUNDER ARE NOT FOR USE IN CONNECTION WITH ANY NUCLEAR, MEDICAL, LIFE-SUPPORT AND RELATED APPLICATIONS. Buyer accepts Goods with the foregoing understanding, agrees to communicate the same in writing to any subsequent purchasers or users and to defend, indemnify and hold harmless Seller from any claims, losses, suits, judgments and damages, including incidental and consequential damages, arising from such use, whether the cause of action be based in tort, contract or otherwise, including allegations that the Seller's liability is based on negligence or strict liability.

12. **ASSIGNMENT:** Buyer shall not assign its rights or delegate its duties hereunder or any interest herein without the prior written consent of Seller, and any such assignment, without such consent, shall be void.

13. **QUANTITY:** Buyer agrees to accept overruns of up to ten percent (10%) of the order on "made-to-order" goods, including parts. Any such additional items shall be priced at the price per item charged for the specific quantity ordered.

14. **REPLACEMENT / SERVICE GOODS:** Upon the cancellation or fulfillment of this order, Seller will have no obligation to sell and Buyer will have no obligation to purchase the Goods sold hereunder, including, but not limited to, the supply of replacement parts for Goods or Goods for Buyer's consumer service division. Seller is not obligated to sell Buyer or its consumer service divisions Goods: (i) for any fixed period of time after production of the Goods supplied hereunder ceases or after the last date of shipment made under this order; or (ii) at any pre-established price to fulfill Buyer's or its consumer service divisions requirements during or after production of the Goods ceases or after the last date of shipment under this order. Seller shall have the absolute right to revise the price of Goods and the terms of sale and to modify or discontinue the sale of the Goods, and such action shall not form the basis of any claim by Buyer against Seller.

15. **TOOLING:** Tool, die, and pattern charges, if any, are in addition to the price of the Goods and are due and payable upon completion of the tooling. All such tools, dies and patterns shall be and remain the property of Seller. Charges for tools, dies, and patterns do not convey to Buyer, title, ownership interest in, or rights to possession or removal, or prevent their use by Seller for other purchasers, except as otherwise expressly provided by Seller and Buyer in writing with reference to this provision.

16. **INSPECTION/TESTING:** Buyer, at its option and expense, may inspect and observe the testing by Seller of the Goods for compliance with Seller's standard test procedures prior to shipment, which inspection and testing shall be conducted at Seller's plant at such reasonable time as is specified by Seller. Any rejection of the Goods must be made promptly by Buyer before shipment. Tests shall be deemed to be satisfactorily completed and the test fully met when the Goods meet Seller's criteria for such procedures.

17. **DRAWINGS:** Seller's prints and drawings (including without limitation, the underlying technology) furnished by Seller to Buyer in connection with this agreement are the property of Seller and Seller retains all rights, including without limitation, exclusive rights of use, licensing and sale. Possession of such prints or drawings does not convey to Buyer any rights or license, and Buyer shall return all copies (in whatever medium) of such prints or drawings to Seller immediately upon request therefor.



18. **EXPORT/IMPORT:** Buyer agrees that all applicable import and export control laws, regulations, orders and requirements, including without limitation those of the United States and the European Union, and the jurisdictions in which the Seller and Buyer are established or from which Goods may be supplied, will apply to their receipt and use. In no event shall Buyer use, transfer, release, import, export, Goods in violation of such applicable laws, regulations, orders or requirements.

19. **GENERAL PROVISIONS:** These terms and conditions supersede all other communications, negotiations and prior oral or written statements regarding the subject matter of these terms and conditions. No change, modification, rescission, discharge, abandonment, or waiver of these terms and conditions shall be binding upon the Seller unless made in writing and signed on its behalf by a duly authorized representative of Seller. No conditions, usage of trade, course of dealing or performance, understanding or agreement purporting to modify, vary, explain, or supplement these terms and conditions shall be binding unless hereafter made in writing and signed by the party to be bound, and no modification or additional terms shall be applicable to this agreement by Seller's receipt, acknowledgment, or acceptance of purchase orders, shipping instruction forms, or other documentation containing terms at variance with or in addition to those set forth herein. Any such modifications or additional terms are specifically rejected and deemed a material alteration hereof. If this document shall be deemed an acceptance of a prior offer by Buyer, such acceptance is expressly conditional upon Buyer's assent to any additional or different terms set forth herein. No waiver by either party with respect to any breach or default or of any right or remedy, and no course of dealing, shall be deemed to constitute a continuing waiver of any other breach or default or of any other right or remedy, unless such waiver be expressed in writing and signed by the party to be bound. All typographical or clerical errors made by Seller in any quotation, acknowledgment or publication are subject to correction.

The validity, performance, and all other matters relating to the interpretation and effect of this agreement shall be governed by the law of the state of Delaware without regard to its conflicts of laws principles. Buyer and Seller agree that the proper venue for all actions arising in connection herewith shall be only in Delaware and the parties agree to submit to such jurisdiction. No action, regardless of form, arising out of transactions relating to this contract, may be brought by either party more than two (2) years after the cause of action has accrued. The U.N. Convention on Contracts for the International Sales of Goods shall not apply to this agreement.

Appliance Parts Catalog

Table of Contents

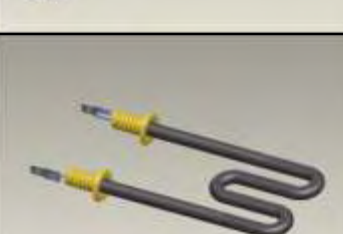
A	Range Surface Elements And Accessories	
B	Bake & Broil Elements And Accessories	
C	Water Heater Elements And Accessories	
D	Special Purpose Heating Elements	
E	Cross Reference	

Backer EHP

4700 John Bragg Highway
Murfreesboro, TN 37127
(615) 907-6900
<http://www.backerehp.com>



Backer

A

Range Surface Elements and Accessories



Backer EHP

4700 John Bragg Highway

Murfreesboro, TN 37127

(615) 907-6900

<http://www.backerehp.com>



Backer

Catalog # DA-707

Range Elements

Standard Plug-In Unit

Type SP-MA

These moderately priced units are authentic replacements supplied as OEM equipment since 1962.



Unit Size	Coil Specifications		Description	Catalog No.	Product Code No.	
	Volts	Watts			Boxed	Bulk Pak
Small	240	1250	3 turn coil, Delta Support	SP12MA	403774	404101
Large	240	2100	4 turn coil, Delta Support	SP21MA	403782	404110

Economy Plug-In Unit

Type SP-YA

Economically priced 3 and 4 turn surface elements with "Y" support. Supplied as original equipment on many late model ranges.



Unit Size	Coil Specifications		Description	Catalog No.	Product Code No.	
	Volts	Watts			Boxed	Bulk Pak
Small	240	1250	3 turn coil, Y Support	SP12YA	--	404064
Large	240	2100	4 turn coil, Y Support	SP21YA	--	404072

Deluxe Plug-In Unit

Type MP-MA

This unit is identical to, and replaces original equipment supplied by many range manufacturers.



Unit Size	Coil Specifications		Description	Catalog No.	Product Code No.	
	Volts	Watts			Boxed	Bulk Pak
Small	240	1500	4 turn coil, Delta Support	MP15MA	404777	404195
	208	1125				
Large	240	2100	5 turn coil, Delta Support	MP21MA	404785	404208
	208	1575				
	240	2600				
208	1950					

Economy Plug-In Unit

Type MP-YA

4 and 5 turn elements with "Y" support. Supplied as original equipment on many late model ranges.



Unit Size	Coil Specifications		Description	Catalog No.	Product Code No.						
	Volts	Watts			Boxed	Bulk Pak					
Small	240	1500	4 turn coil, Y Support	MP15YA	--	404080					
Large	240	2100	5 turn coil, Y Support	MP21YA	--	404089					
							240	2600	MP26YA	--	404056



Backer

Range Elements

GE-Hotpoint Look-Alikes

Double Coil Hard Wired 5 and 6 Turn Elements. Both sizes available with standard or high-rise configuration. All units are individually packaged in an attractive, sturdy polyethelene bag.

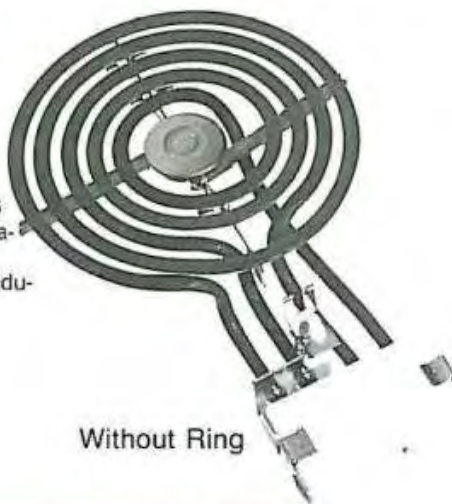

Without Ring



With Ring

Unit Size	Coil Specifications		Description	Catalog No.	PCN
	Volts	Watts			Bagged
Small Large	240	1325	With Ring	CH30X356 CH30X354	404566
		2125			404574
Small Large	240	1325	High-Rise (less ring)	CH30X342 CH30X341	404582
		2125			404590

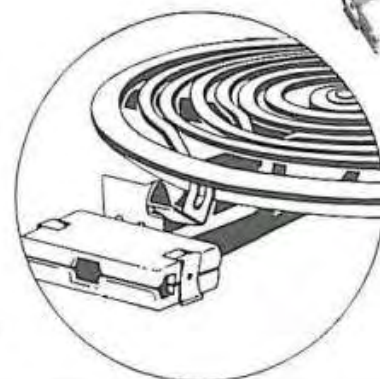

Detailed view

GE Style Plug-In Surface Elements

GE Style Plug-In

The small GE style range surface element has a 5-turn configuration while the large unit has 6-turns. All units are individually packaged in an attractive clear polyethelene bag or bulk packaging.



GE Style Plug-In

New GE style range surface element designed to replace GE # WB30X5071 (30M0001) and WB30X5072 (30M0002). Used on many later model GE ranges.



Unit Size	Coil Specifications		Catalog No.	Product Code No.	
	Volts	Watts		Bagged	Bulk Pak
Small Large	208/240	1000/1325	CH30X218 CH30X219	404988	407601
		1765/2350		404996	407610

Unit Size	Coil Specifications		Catalog No.	Product Code No.	
	Volts	Watts		Boxed	Bulk
Small	240	1325	CH30M1	407812	407804
Large	240	2350	CH30M2	407839	407820



Backer

Range Elements

Adapt-O-Matic Line

Type MP-U

Elements may be used as direct plug-in style or hard wired with the use of our AK Adapt-O-Kit.



This complete unit includes an Adapt-O-Matic element, coil support with enameled medallion, spill-trapping drip pan, chrome-plated trim ring and Adapt-O-Kit.



Adapt-O-Matic Elements

Unit Size	Coil Specifications		Description	Catalog No.	Product Code No.
	Volts	Watts			
Small	240	1500	4 turn (Adapt-O-Matic element and Adapt-O-Kit)	MP15U	403512
	208	1125			
Large	240	2100	5 turn	MP21U	403520
	208	1575			

Complete Adapt-O-Matic Assembly

Unit Size	Coil Specifications		Description	Catalog No.	Product Code No.
	Volts	Watts			
Small	240	1500	4 turn (Adapt-O-Matic Element, Adapt-O-Kit, Ring Adapter and Drip Pan)	MP15U-R6R	403580
	208	1125			
Large	240	2100	5 turn	MP21U-R9R	403598
	208	1575			

Adapt-O-Kit available separately. See page A-9.

Older Style Plug-Ins (prior to 1961)

Type MP-M MCP-M

These replacement elements are the exact ones used as original equipment on ranges built prior to 1961.

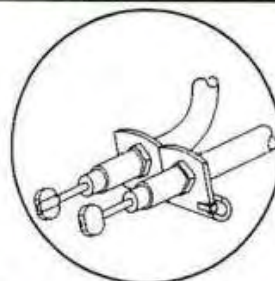

Detailed view showing special "toggle" ground bracket.



Single Coil Units

Unit Size	Coil Specifications		Catalog No.	Product Code No.
	Volts	Watts		
Small	240	1500	MP15M	400160
	208	1125		
Large	240	2100	MP21M	400178
	208	1575		

Terminal Blocks. See Page A-9.

Double Coil Units

Unit Size	Coil Specifications		Catalog No.	Product Code No.
	Volts	Watts		
Small	240	1500	MCP45M	400143
	208	1125		
Large	240	2100	MCP80M	400151
	208	1575		
Large	240	2600	MCP85M	400899
	208	1950		

Terminal Blocks. See Page A-9.



Backer

Range Elements

Single Coil Hard Wired

Type S-MD M-MD

Hard wired elements used on most ranges prior to 1961 and newer special applications.



Single Coil Elements Leadwire Attached

Type SM-MD

Top range elements with wires permanently attached by high temperature heat shrink sleeve.



Single Coil Hard Wired

Unit Size	Coil Specifications			Catalog No.	Product Code No.	
	Volts	Watts	Description		Boxed	Bulk Pak
Small	240	1250	3 turn w/term. block	S12MD	404507	404646
Large	240	2100	4 turn w/term. block	S21MD	404494	404654
Small	240	1500	4 turn w/term. block	M15MD	404806	404662
Large	240	2100	5 turn w/term. block	M21MD	404814	404670
Large	240	2600	5 turn w/term. block	M26MD	404822	407409

Unit Size	Coil Specifications			Catalog No.	Product Code No.	
	Volts	Watts	Description		Boxed	Bulk Pak
Small	250	1250	3 turn small w/lead wires attached	SM12MD	406983	404232
Large	250	2100	4 turn large w/lead wires attached	SM21MD	406991	404240

Hotplates

Hard Wired and Plug-in Terminals

These versatile 3-turn hotplate elements can be used as replacements in hotplates, table ranges, buffet ranges, small marine craft, portable appliances and a myriad of other uses.



Hard Wire

120-volt hotplate elements are available in 550 and 1100 watts for plug-in models and 550, 900 and 1100 watts in models with hard wired terminals. Hardwired models come equipped with a high-temperature phenolic terminal block and terminal screws.



Plug-in

Coil Specifications		Description	Catalog No.	Product Code No.
Volts	Watts			
120	550	3-turn coil, hard wired, medallion, coil support and terminal block	S51YD	456219
120	900		S01YD	456227
120	1100		S111YD	456235
120	550	3-turn coil, plug-in, coil support and medallion	SP51YA	456788
120	1100		SP111YA	456796



Backer

Range Elements

Plug-In "Canner Cooker" Element

Plug-In Canner Cooker element has a heavy duty delta support which allows the element to sit 1/4" higher on the range. This allows for better support and air flow under heavy pots when canning.



Unit Size	Coil Specifications		Catalog No.	Product Code No.	
	Volts	Watts		Boxed	Bulk
Large	208/ 240	1955/ 2600	MP26KA	404291	404304

Standard Pans, Rings and Bowls



Part	Description	Cat. No.	Product Code No.	
			Boxed	Bulk
Ring	6" - Small	R6R	400231	401592
	8" - Large	R9R	400274	401605
Pan	6" - Small	6SP-1	400370	401613
	8" - Large	9SP-1	400389	401621
Bowl	6" - Small	CPS	--	404179
	8" - Large	CPL	--	404187

Direct Replacement Pans, Rings and Bowls



Part	Replaces OEM No.	Boxed		Bulk	
		Cat. No.	PCN	Cat. No.	PCN
Pan	WB32X5045	CH114	401656	CH214	401664
	WB32X5036	CH115	401672	CH215	401680
Ring	WB31X5013	CH104	401699	CH204	401701
	WB31X5014	CH105	401710	CH205	401728
Bowl	WB31X5010	CH101	401736	CH201	401744
	WB31X5011	CH102	401752	CH202	401760
Bowl	Q147221	CH106	401779	CH206	401787
	Q147223	CH107	401795	CH207	401808

Monotube Accessories



Monotube Parts

Part	Description	Catalog Number	Product Code Number
Rings	6" for 6" - 1/2" opening	TK-6R	460306
	8" for 8" - 1/2" opening	TK-8R	460314
Pans	6" pan (Aluminum)	TK-6PA	460410
	8" pan (Aluminum)	TK-8PA	460429
Supports	6" support only	TK-6S	460381
	8" coil support only	TK-8S	460390
Medallion	enameled medallion	TK-M	460402



Backer

Range Elements

Tappan Plug-In Block

Type TRB

This is the original block assembly for TAPPAN Plug-In Range Surface Elements. A ¼" male spade terminal connector is built-in for quick connection.

Cat. No.	Product Code No.
TRB	403934



Terminal Block Assembly

Type GMP

Terminal block required when using Chromalox MP units as a replacement for 30X218, 30X219.

Cat. No.	Product Code No.
GMP	404339



Universal Plug-In Block

Newer style block for most standard single coil plug-in surface elements.

Cat. No.	Product Code No.
CH300V	403504



Sorry
This Item
Is No Longer
Available

Adapt-O-Kit

Kit to convert Plug-in to hard wired terminal (see MPU page A-5).

Cat. No.	Product Code No.
AK	403547



Universal Plug-In Block and Bracket Assembly

Quick-connect version (UPR) for single coil plug-in range surface elements used as original equipment by: KELVINATOR — WHIRLPOOL — CHAMBERS — COLUMBUS STOVE — KENMORE — HARDWICK STOVE — PREWAY — PHILIPS AND BUTTORFF — NUTONE — PEERLESS — ROYAL CHEF and others. Screw-type version (UPS) used as original equipment by MAGIC CHEF.

Complete Assembly



UPR

UPS

Complete Assembly

Type of Connection	Catalog No.	Product Code No.
Quick	UPR	403408
Screw	UPS	403416

Block Only

Type of Connection	Catalog No.	Product Code No.
Quick	5-18601	400362

Block Only



Terminal Block

Terminal blocks used with "old style" (type MP-M and MCP-M) single and double coil range surface elements shown on page A-5.



1-17786

2-17786

Description	Catalog No.	Product Code No.
Terminal Block Single Coil	1-17786	400346
Terminal Block Double Coil	2-17786	400354



Backer

Range Elements

Infinite Control Switches

Type UC

Type UC switch kits contain either a 120 or 240 volt switch, mounting adapter parts and an assembly of various dial knob adapters which will adapt to virtually any knob. If not, use kit UC120K or UC240K which includes a knob. Dual voltage or "flasher" type switches cannot be replaced by UC style.



Switch Kits

Volts	Description	Catalog No.	Product Code No.
120	Switch, mounting adapter parts, knob adapters	UC120	470037
240		UC240	470010
120	Switch, mounting adapter parts, knob adapters and dial knob	UC120K	470045
240		UC240K	470029
Dial knobs (available separately)			
—	White knob	1-45936	470109
—	Black knob	2-45936	470117

Type UCP

These infinite replacement kits provide replacement for infinite and 3, 5, 7 heat switches. Features push to turn operation. Knob turns in either direction. Includes mounting and dial knob adapters.



Switch Kits

Volts	Description	Catalog No.	Product Code No.
120	Switch, mounting adapter parts, knob adapters	UCP120	470133
240		UCP240	470125

Medallion



NP-4



EP-4



TK-M

Part	Description	Catalog No.	Product Code No.
Medallion	For Delta support	NP4	401955
	For "Y" Support	EP4	401963
	For TK monotube	TK-M	460402

Packing Cartons

Folding corrugated self-locking cartons. Shipped flat.

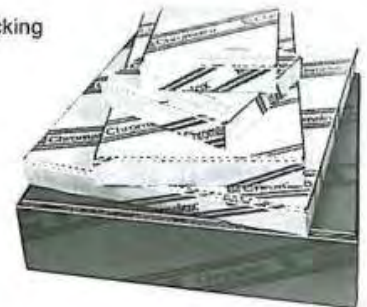

Size	Description	PCN
20 ³ / ₈ " × 22 ³ / ₈ " × 5 ¹ / ₂ "	10 Pack Master Carton for oven elements	492050
21 ³ / ₄ " × 19 ³ / ₄ " × 1 ⁷ / ₈ "	Individual Pack for large oven elements	492017
21 ³ / ₄ " × 13 ¹ / ₈ " × 1 ⁷ / ₈ "	Individual Pack for small oven elements	492041
10 ¹ / ₈ " × 10 ¹ / ₈ " × 1 ¹³ / ₁₆ "	Individual Pack for large size surface elements	492025
9" × 9" × 1 ¹³ / ₁₆ "	Individual Pack for small surface elements	492033



Backer

B

Bake & Broil Elements and Accessories



Backer EHP





4700 John Bragg Highway
Murfreesboro, TN 37127
(615) 907-6900
<http://www.backerehp.com>

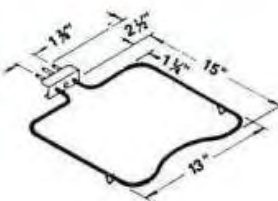
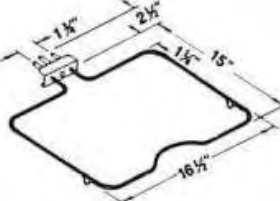
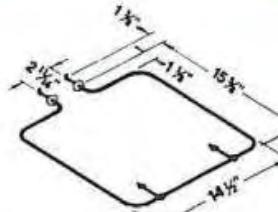
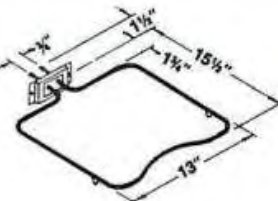
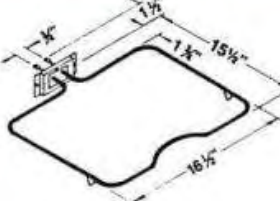
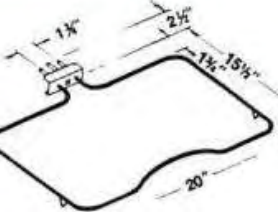
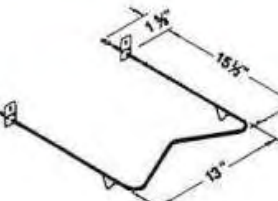

Backer

Catalog # DA-707

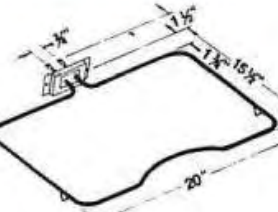
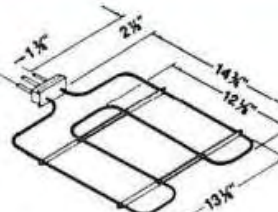
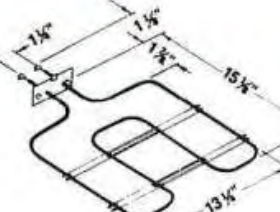



Bake & Broil Elements

<p>ROP-N 400477</p>  <p>Univ. Plug-In Bake</p> <p>WATTS 2300 VOLTS 250</p>	<p>ROP-T 400485</p>  <p>Univ. Plug-In Bake</p> <p>WATTS 2500 VOLTS 250</p>	<p>RTB 400530</p>  <p>Universal Broil This is a browning element - to be used with RTA when two-circuit broil needed.</p> <p>WATTS 500 VOLTS 250</p>
<p>ROA-N 400400</p>  <p>Universal Hinged Bake</p> <p>WATTS 2300 VOLTS 250</p>	<p>ROA-T 400901</p>  <p>Universal Hinged Bake</p> <p>WATTS 2500 VOLTS 250</p>	<p>ROP-W 400493</p>  <p>Univ. Plug-In Bake</p> <p>WATTS 2700 VOLTS 250</p>
<p>ROU-N 400506</p>  <p>Universal Hinged Bake</p> <p>WATTS 2200 VOLTS 250</p>	<p>ROU-T 403037</p>  <p>Universal Hinged Bake</p> <p>WATTS 2200 VOLTS 250</p>	<p>ROA-W 400418</p>  <p>Universal Hinged Bake</p> <p>WATTS 2700 VOLTS 250</p>
<p>RTP 400549</p>  <p>Universal Plug-In Broil</p> <p>WATTS 3000 VOLTS 250</p>	<p>RTA 400522</p>  <p>Univ. Perm. Mount Broil</p> <p>WATTS 3000 VOLTS 250</p>	<p>ROU-W 400514</p>  <p>Universal Hinged Bake</p> <p>WATTS 2500 VOLTS 250</p>

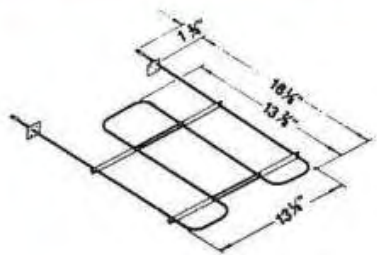
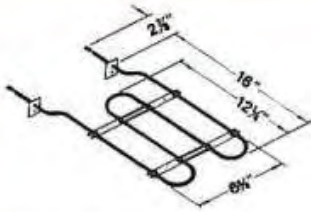

Backer

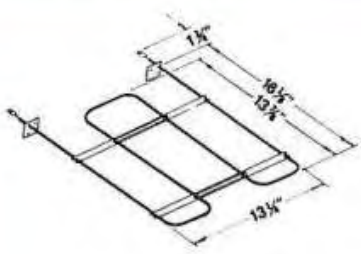
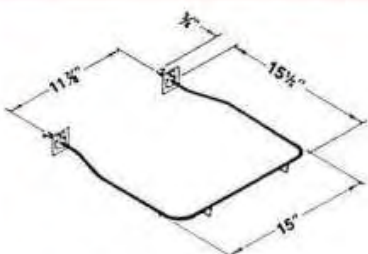
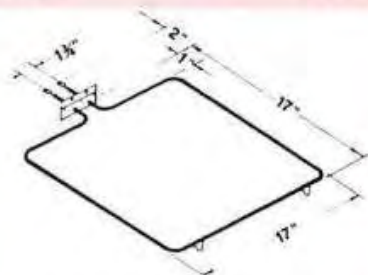
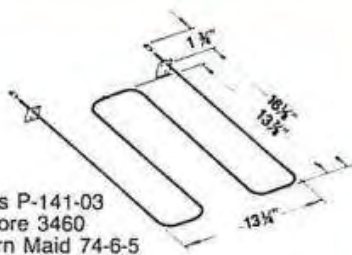
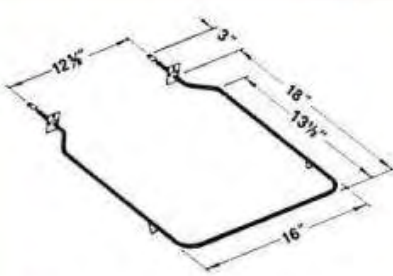
Bake & Broil Elements

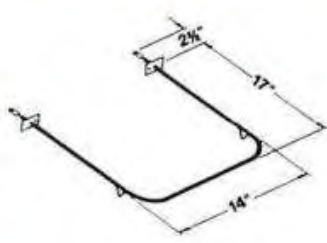
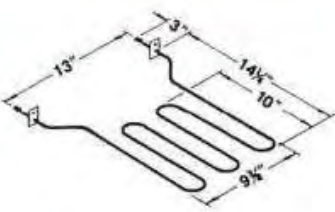
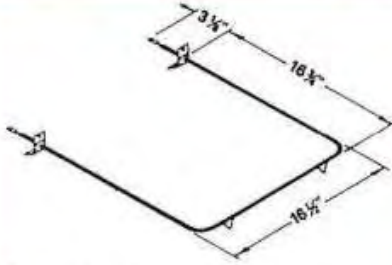
<p>RTU 400557</p>  <p>Univ. Perm. Mount Broil</p> <p>WATTS 3000 VOLTS 250</p>	<p>CH527 454184</p>  <p>Columbus 0187-04; C-187-02; C-180-04; 07399-04 Sunray 07399 Kelvinator 1301722</p> <p>WATTS 2400 VOLTS 240</p>	<p>CH555 456104</p>  <p>Thermador</p> <p>WATTS 2200 VOLTS 240</p>
<p>CH515 453000</p>  <p>National</p> <p>WATTS 3000 VOLTS 250</p>	<p>CH528 453026</p>  <p>Whirlpool 270400 RCA-Whirlpool 261528 RCA-Whirlpool 268765</p> <p>WATTS 2200 VOLTS 240</p>	<p>CH556 453739</p>  <p>Magic Chef 1938-261; 106A-940M</p> <p>WATTS 2250 VOLTS 250</p>
<p>CH515G3 453018</p>  <p>Athens P-141-03 Kenmore 3460 Modern Maid 74-6-5 Vesta P-141-03 Kelvinator 1300899; 1302026; 1188746; 1188474</p> <p>WATTS 3000 VOLTS 250</p>	<p>CH550 453034</p>  <p>Modern Maid 74-6-99; 74-6-121</p> <p>WATTS 2600 VOLTS 240</p>	<p>CH557 453860</p>  <p>Sorry This Item Is No Longer Available</p> <p>Detroit Jewell Weilbilt 9-36 Waste King</p> <p>WATTS 2000 VOLTS 240</p>
<p>CH518 455902</p>  <p>National 303</p> <p>WATTS 2300 VOLTS 240</p>	<p>CH554 453042</p>  <p>Perm. Mount Broil Modern Maid 74-6-49</p> <p>WATTS 3000 VOLTS 250</p>	<p>CH558 454213</p>  <p>Detroit Jewell Weilbilt 9-36 Waste King</p> <p>WATTS 2250 VOLTS 240</p>



Backer

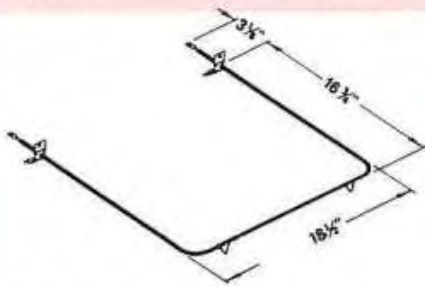
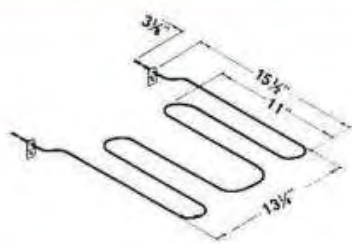
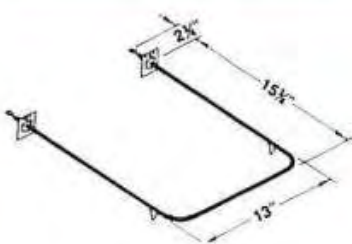
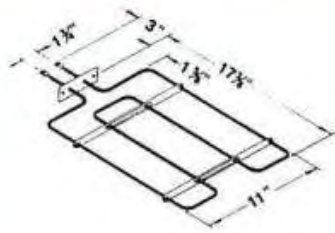
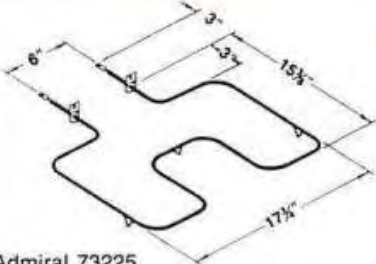
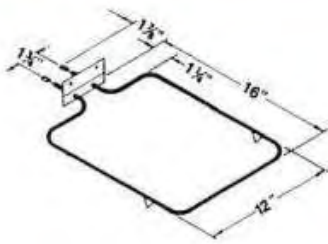
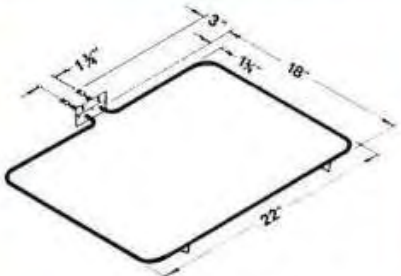
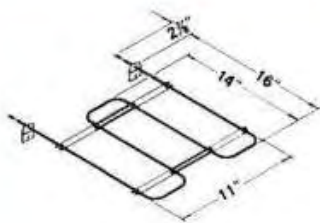
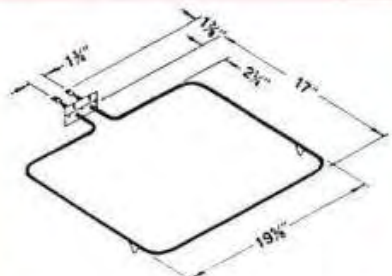
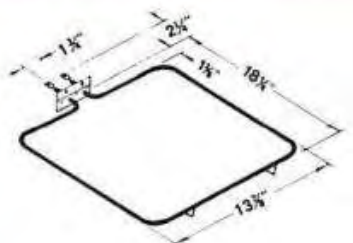
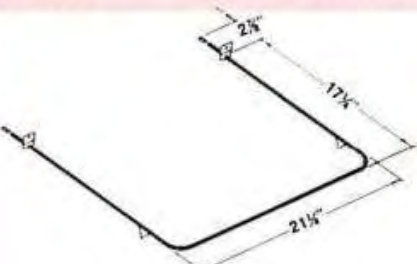
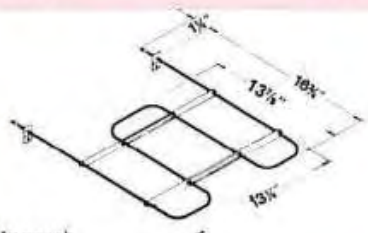

Bake & Broil Elements

<p>CH559 453878</p>  <p>Detroit Jewell Welbilt 9-52 Waste King</p> <p>WATTS 2500 VOLTS 240</p>	<p>CH583 453886</p>  <p>Modern Maid 74-6-60; 74-6-164</p> <p>WATTS 3600 VOLTS 250</p>	<p>CH587 453958</p>  <p>Modern Maid 74-6-45; 74-6-69</p> <p>WATTS 2200 VOLTS 240</p>
<p>CH562 453069</p>  <p>Enterprise 150512</p> <p>WATTS 3000 VOLTS 250</p>	<p>CH584 453093</p>  <p>Admiral 73225 221T011P07; 221T011P10; 221T017P01</p> <p>WATTS 2400 VOLTS 250</p>	<p>CH588 453915</p>  <p>Admiral</p> <p>WATTS 2200 VOLTS 240</p>
<p>CH563 453077</p>  <p>Enterprise 150611</p> <p>WATTS 2800 VOLTS 240</p>	<p>CH585 453894</p>  <p>Gibson 54481; 55322; 54706; 43820</p> <p>WATTS 3000 VOLTS 250</p>	<p>CH590 454221</p>  <p>Admiral 34981-2 Wedgewood</p> <p>WATTS 3000 VOLTS 240</p>
<p>CH564 453085</p>  <p>Enterprise 150612</p> <p>WATTS 2000 VOLTS 240</p>	<p>CH586 453907</p>  <p>Gibson 54480; 54017; 43819; 44521</p> <p>WATTS 2800 VOLTS 240</p>	<p>CH591 453384</p>  <p>Monarch Kenmore Gaffers & Sattler 332-10 Magic Chef West 332-10; 332-181; 332-196C</p> <p>WATTS 3000 VOLTS 250</p>



Backer

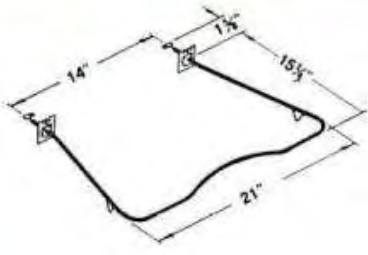
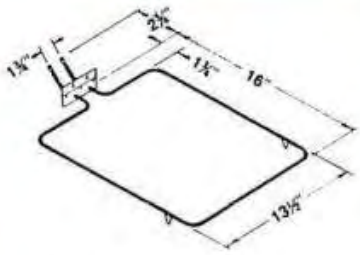
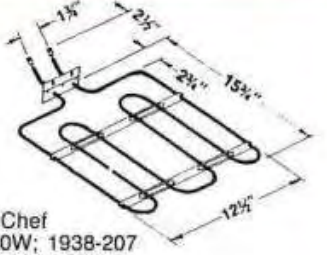
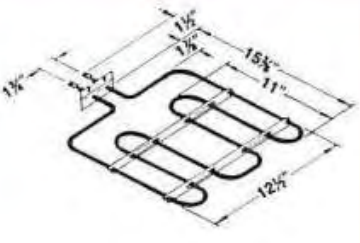
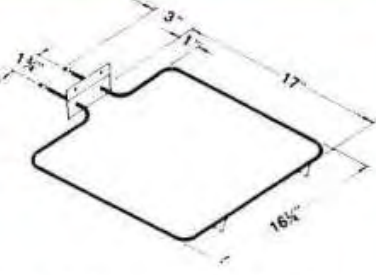
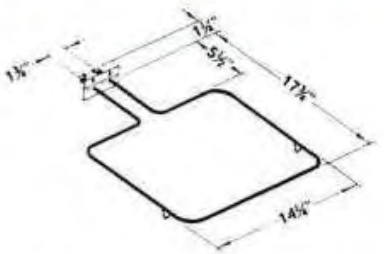
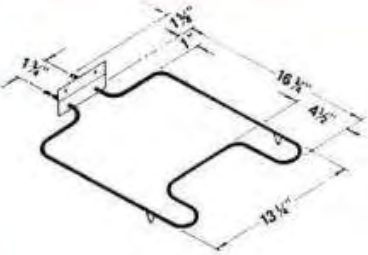

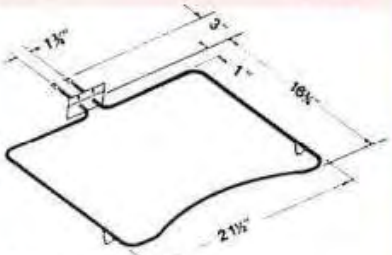
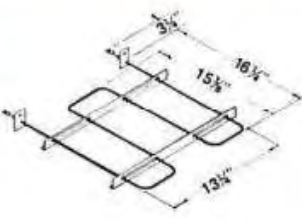
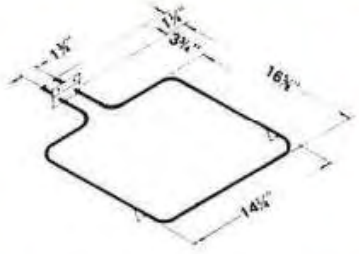

Bake & Broil Elements

<p>CH592 453931</p>  <p>Monarch</p> <p>WATTS 2600 VOLTS 240</p>	<p>CH596 454010</p>  <p>Magic Chef 106A-35M; 1938-243</p> <p>WATTS 1800 VOLTS 250</p>	<p>CH602 454248</p>  <p>Magic Chef 106-120W; 1938-207 Wizard 106-120W Dixie 106-120W Montgomery Ward 106-120W</p> <p>WATTS 3000 VOLTS 240</p>
<p>CH593 452103</p>  <p>Kenmore 39127 Waste King 728184</p> <p>WATTS 3600 VOLTS 240</p>	<p>CH597 454029</p>  <p>Magic Chef 106A-459M; 1938-266</p> <p>WATTS 1800 VOLTS 250</p>	<p>CH604 453106</p>  <p>RCA-Whirlpool 249614; 250546</p> <p>WATTS 2400 VOLTS 240</p>
<p>CH594 454002</p>  <p>Waste King 100271</p> <p>WATTS 3000 VOLTS 250</p>	<p>CH600 456120</p>  <p>Norge 41-3333; 41-2160; 41-1647</p> <p>WATTS 3000 VOLTS 250</p>	<p>CH605 454037</p> <p>Sorry This Item Is No Longer Available</p> <p>Kelvinator 1186441</p> <p>WATTS 3000 VOLTS 250</p>
<p>CH595 453051</p>  <p>Magic Chef 106A-355M 106A-580M; 106A-850M; 1938-254; 1938-264; 1938-328</p> <p>WATTS 2250 VOLTS 240</p>	<p>CH601 451928</p>  <p>Norge 41-4601; 41-5668</p> <p>WATTS 3000 VOLTS 250</p>	<p>CH608 454256</p>  <p>RCA-Whirlpool 250544</p> <p>WATTS 2500 VOLTS 250</p>

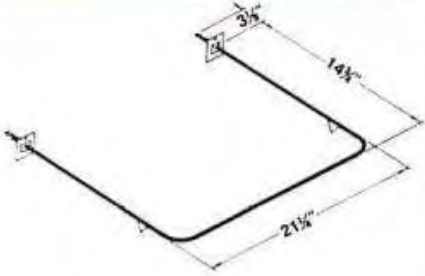
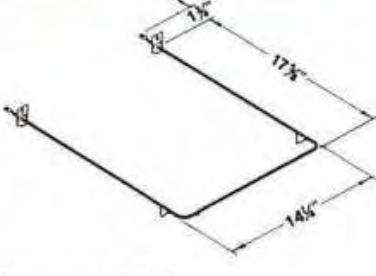
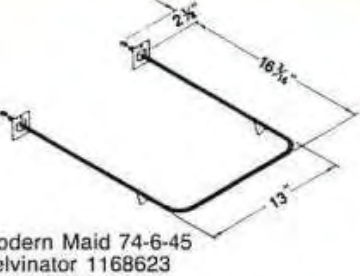
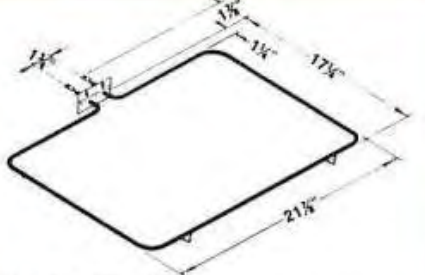

Backer

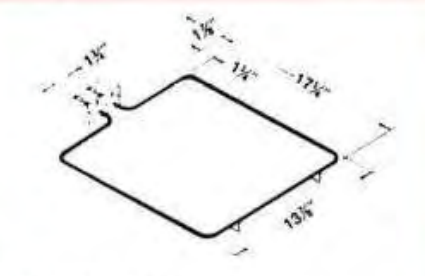
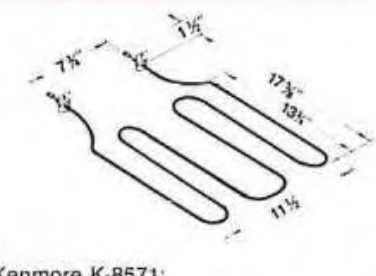
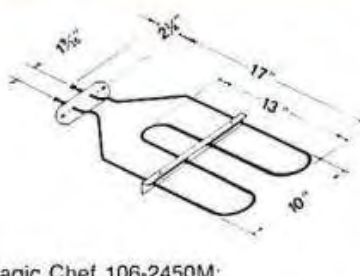
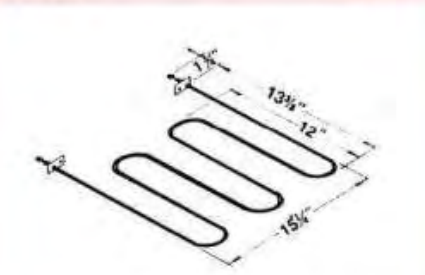
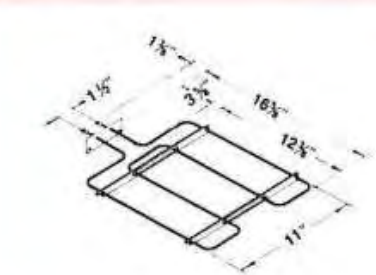
Bake & Broil Elements

<p>CH609 454045</p>  <p>Modern Maid 74-6-6 WATTS 2200 VOLTS 240</p>	<p>CH613 450757</p>  <p>Montgomery Ward 885860 Tappan 221T004P09 WATTS 2200 VOLTS 250</p>	<p>CH620 453843</p>  <p>Modern Maid 74-6-45 Kelvinator 1168623 Sunray 03002 Gibson 39542; 41035 Suburban R23220 WATTS 2200 VOLTS 240</p>
<p>CH610 453114</p>  <p>Athens P-141-02 Kenmore 5927 Vesta P-141-02 WATTS 2400 VOLTS 240</p>		<p>CH621 451901</p>  <p>Sunray 03005 Suburban R23221 Monarch WATTS 3000 VOLTS 240</p>
<p>CH611 450976</p>  <p>Athens P-141-05 Kenmore 3462 Vesta P-141-05 WATTS 2000 VOLTS 240</p>	<p>CH617 453122</p>  <p>Kenmore K-8571; 3212-K10739 Preway K-8571; K-10739; K-10954 WATTS 3000 VOLTS 240</p>	<p>CH622 451709</p>  <p>Magic Chef 106-2450M; 1938-209; 106-1710F; 106-350M; 106-35M; 1938-242; 1938-262 WATTS 2700 VOLTS 250</p>
<p>CH612 451821</p>  <p>Tappan 400-233-3 220T001P01 WATTS 3000 VOLTS 250</p>	<p>CH619 451725</p>  <p>Tappan 01-233-2 Kelvinator 1081520 WATTS 3000 VOLTS 250</p>	<p>CH624 453131</p>  <p>Montgomery Ward 88-5859 Admiral 42202 Tappan 221T008P01; 221T008P03 WATTS 2500 VOLTS 250</p>



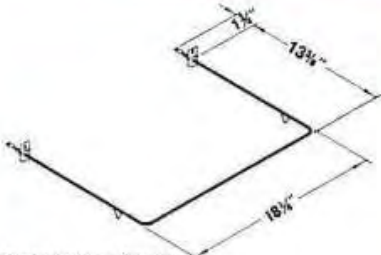
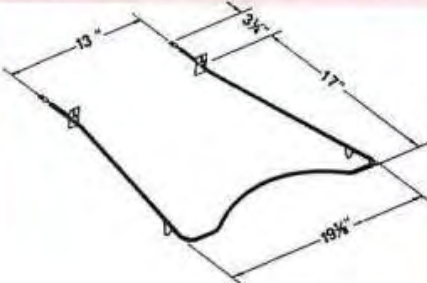
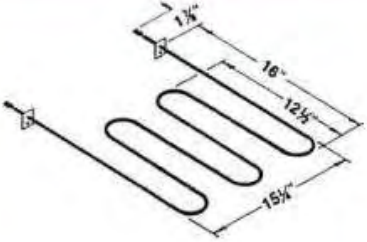
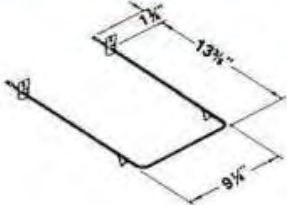
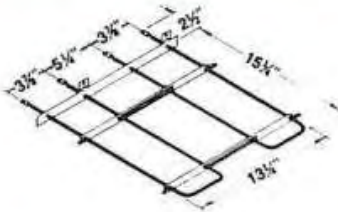
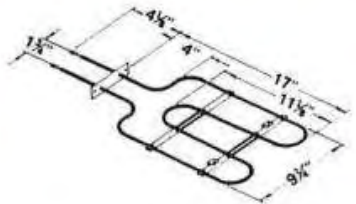
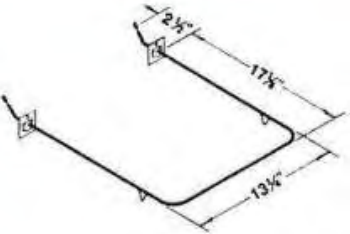
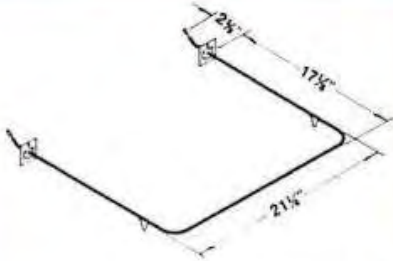
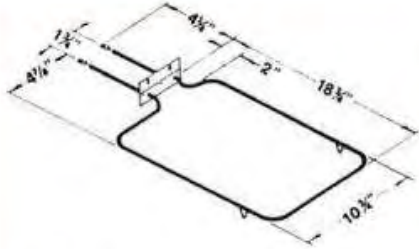
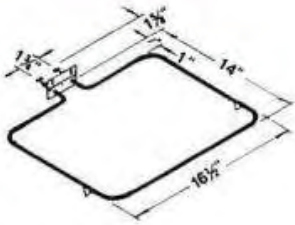
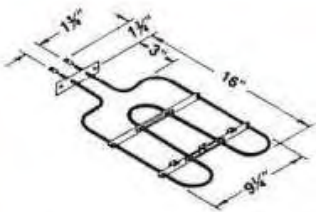
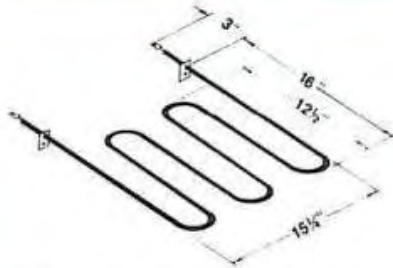

Bake & Broil Elements

<p>CH625 450749</p>  <p>Montgomery Ward 88-5959 Tappan 221T004P01; 221T004P03; 400-233-2</p> <p>WATTS 2000 VOLTS 240</p>	<p>CH629 453149</p>  <p>Kelvinator 1300718 Whirlpool 241215</p> <p>WATTS 2400 VOLTS 250</p>	<p>CH635 454993</p>  <p>Magic Chef 106-940M; 1938-260</p> <p>WATTS 2700 VOLTS 250</p>
<p>CH626 450714</p>  <p>Tappan 221T004P05 O'Keefe & Merritt 221T004P05</p> <p>WATTS 1500 VOLTS 250</p>	<p>CH632 453157</p>  <p>Philco 3204-35</p> <p>WATTS 3000 VOLTS 240</p>	<p>CH636 454272</p>  <p>Magic Chef 106-25M; 106-255M; 1938-236</p> <p>WATTS 2700 VOLTS 250</p>
<p>CH627 454264</p>  <p>Brown 184-2E2</p> <p>WATTS 2300 VOLTS 250</p>	<p>CH633 454053</p>  <p>Brown 184-2E4</p> <p>WATTS 2600 VOLTS 240</p>	<p>CH637 454547</p>  <p>Magic Chef 106A-25M; 1938-237</p> <p>WATTS 1750 VOLTS 250</p>
<p>CH628 453481</p>  <p>Kenmore 38081; 41878; 42163; 303938 Roper 303938</p> <p>WATTS 2000 VOLTS 240</p>	<p>CH634 454539</p>  <p>Magic Chef 106-3620M; 1938-234</p> <p>WATTS 2700 VOLTS 250</p>	<p>CH638 453165</p>  <p>Magic Chef 106-580M; 1938-263</p> <p>WATTS 3200 VOLTS 250</p>



Backer

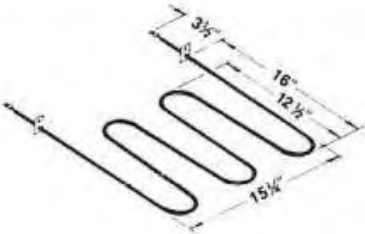
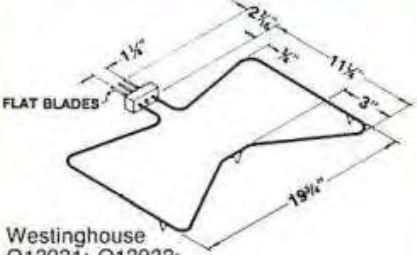
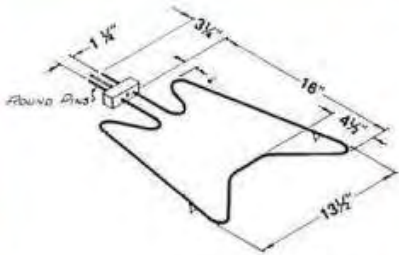

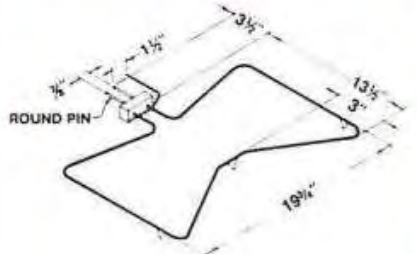
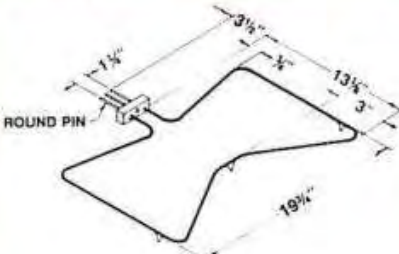
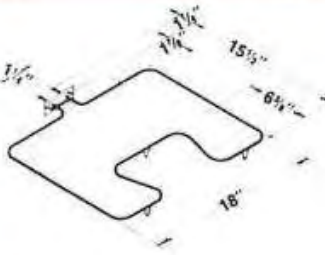
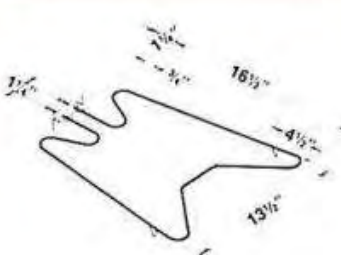
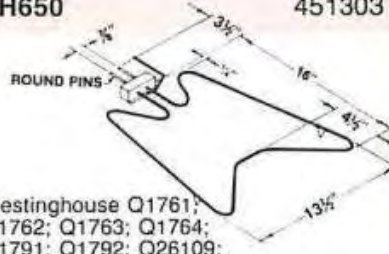
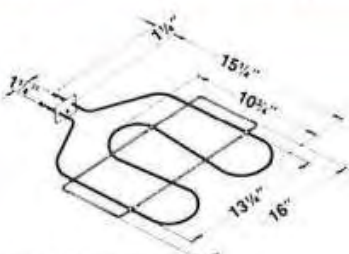
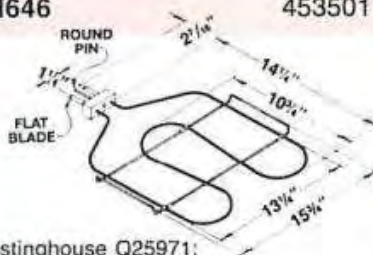
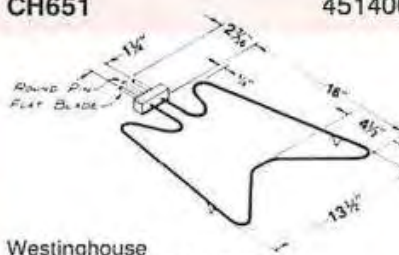



Bake & Broil Elements

<p>CH639 454985</p>  <p>Magic Chef 106-850M; 1938-255</p> <p>WATTS 3200 VOLTS 250</p>	<p>CH643 454070</p>  <p>FLAT BLADES</p> <p>Westinghouse Q13931; Q13932; Q13933; Q13934; Q13935; Q13939; Q13940; Q210521</p> <p>WATTS 2200 VOLTS 250</p>	<p>CH648 451514</p>  <p>ROUND PINS</p> <p>Westinghouse Q58626; Q58628</p> <p>WATTS 2200 VOLTS 250</p>
<p>CH640 454061</p>  <p>RCA-Whirlpool 265619</p> <p>WATTS 1500 VOLTS 240</p>	<p>CH644 454520</p>  <p>ROUND PIN</p> <p>Westinghouse Q53485</p> <p>WATTS 2500 VOLTS 250</p>	<p>CH649 451506</p>  <p>ROUND PIN</p> <p>Westinghouse Q58546; Q58548; Q210972</p> <p>WATTS 2500 VOLTS 250</p>
<p>CH641 453237</p>  <p>Westinghouse Q147361; Q147362; Q147365; Q207517; Q207511</p> <p>WATTS 3000 VOLTS 250</p>	<p>CH645 455021</p>  <p>Westinghouse Q147541; Q147542; Q147545; Q208211; Q210981</p> <p>WATTS 2700 VOLTS 250</p>	<p>CH650 451303</p>  <p>ROUND PINS</p> <p>Westinghouse Q1761; Q1762; Q1763; Q1764; Q1791; Q1792; Q26109; Q26110; 1117906; 1117908; 1145452; 1147728; 1147730; 1349691; 1465524; 1468397; 1468398; Q210951</p> <p>WATTS 2700 VOLTS 250</p>
<p>CH642 453392</p>  <p>Westinghouse Q132562; Q132563; Q138063; Q138064; Q149773; Q149776; Q210941</p> <p>WATTS 2800 VOLTS 250</p>	<p>CH646 453501</p>  <p>ROUND PIN FLAT BLADE</p> <p>Westinghouse Q25971; Q25981; Q25986; Q25999; Q26003; Q26005; Q26010; Q26011; Q26015; Q26018; Q26020; Q83571; Q83573; Q83579; Q83880; Q138053; Q210992</p> <p>WATTS 2800 VOLTS 250</p>	<p>CH651 451400</p>  <p>ROUND PIN FLAT BLADE</p> <p>Westinghouse Q26090; Q26092; Q26098; Q26101; Q26102; Q26105; Q26129; Q26131; Q26135; Q26136; Q26139; Q26140; Q26141; Q26142; Q26143; Q26144; Q210961</p> <p>WATTS 2700 VOLTS 250</p>

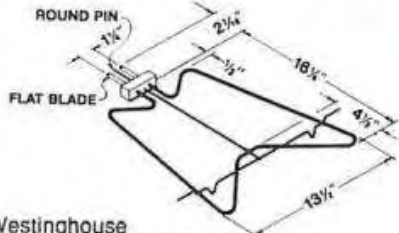
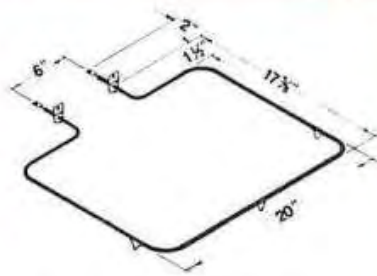

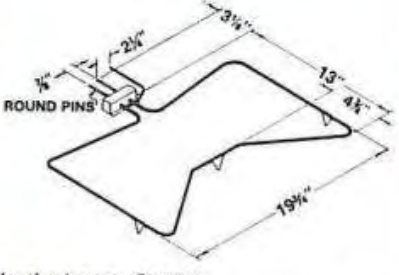
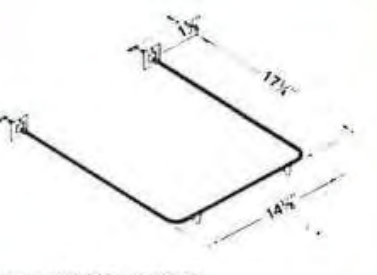
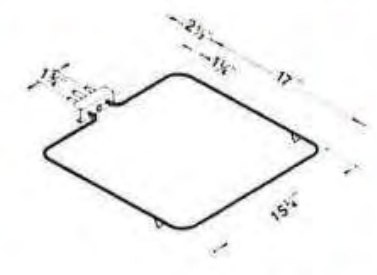
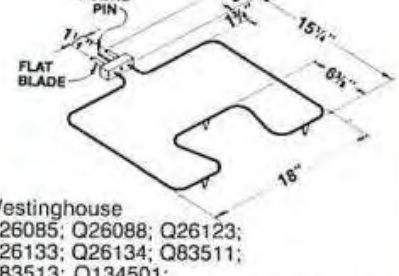
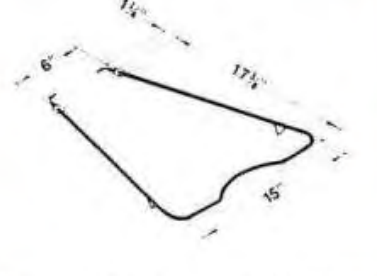
Backer

Bake & Broil Elements

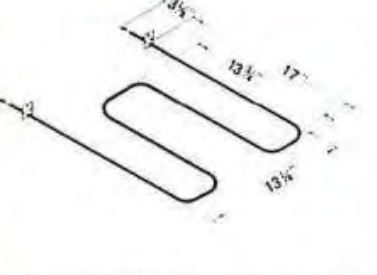
<p>CH651W 456171</p>  <p>Westinghouse Q26090; Q26092; Q26098; Q26101; Q26102; Q26129; Q26131; Q26135; Q26136; Q26139; Q26140; Q26141; Q26143; Q26144; Q26149</p> <p>WATTS 2500 VOLTS 250</p>	<p>CH654 451004</p>  <p>Tappan 85-233-21; 221T004P11; 221T004P13</p> <p>WATTS 3000 VOLTS 250</p>	<p>CH656W 450968</p>  <p>Kelvinator 1187527; 1187761; 1188705</p> <p>WATTS 2600 VOLTS 240</p>
<p>CH652 451311</p>  <p>Westinghouse Q1784; Q1785; Q26114; Q26115; Q216581</p> <p>WATTS 2500 VOLTS 250</p>	<p>CH655 453181</p>  <p>Preway K-6338; K-7677; K-8893; K-9550 Kenmore 1408-K6338</p> <p>WATTS 1800 VOLTS 240</p>	<p>CH657 451223</p>  <p>Kelvinator 1185307</p> <p>WATTS 2400 VOLTS 240</p>
<p>CH653 451418</p>  <p>Westinghouse Q26085; Q26088; Q26123; Q26133; Q26134; Q83511; Q83513; Q134501; Q134502; Q134503; Q134504; Q210911</p> <p>WATTS 3000 VOLTS 250</p>	<p>CH655W 450950</p>  <p>Kelvinator 1187528; 1188706</p> <p>WATTS 2400 VOLTS 240</p>	<p>CH658 451733</p>  <p>Sorry This Item Is No Longer Available</p> <p>Kelvinator 1143907</p> <p>WATTS 3000 VOLTS 250</p>
<p>CH653W 455187</p>  <p>Westinghouse Q26085; Q26088; Q26123; Q26133; Q83511; Q83513; Q134501; Q134502; Q134503; Q134504</p> <p>WATTS 3000 VOLTS 250</p>	<p>CH656 453190</p>  <p>Gibson Y39672; Y41036; Y54066 Philco 3204-2; 3204-8</p> <p>WATTS 2500 VOLTS 240</p>	<p>CH659 453923</p>  <p>Kelvinator 1300899, 1302026</p> <p>WATTS 3000 VOLTS 250</p>



Backer

Bake & Broil Elements

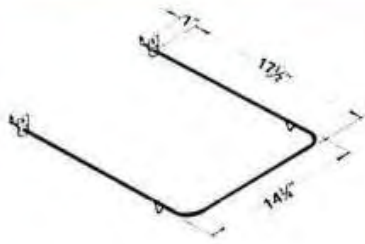
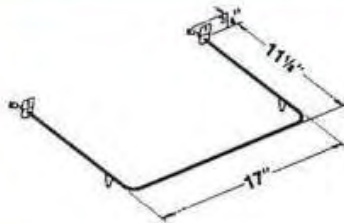
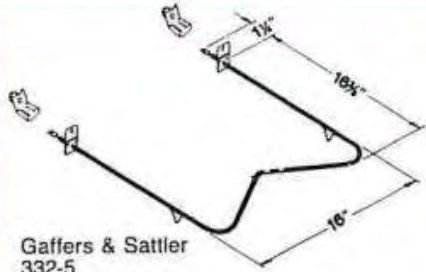
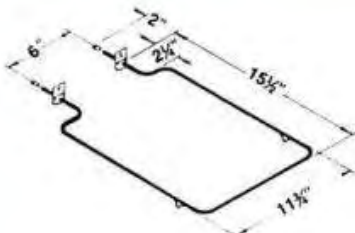
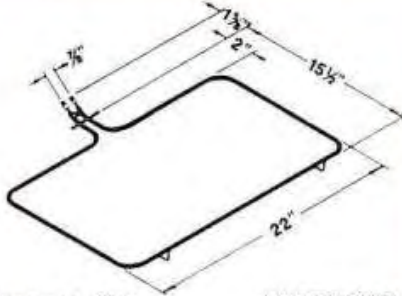
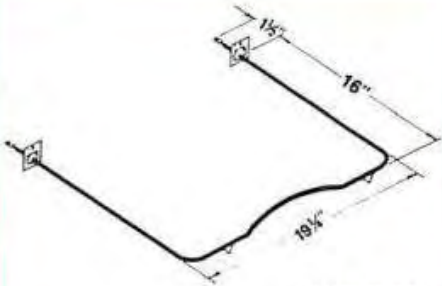
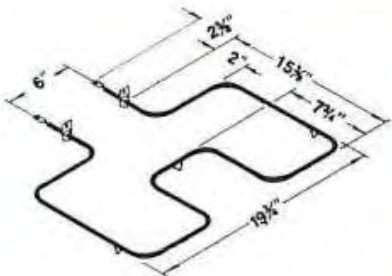
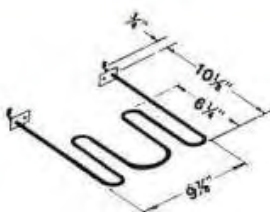
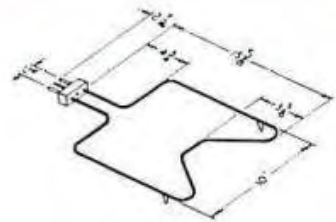
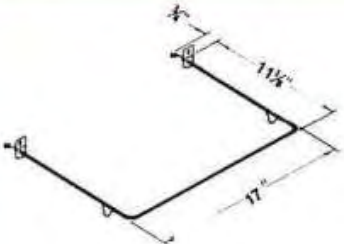
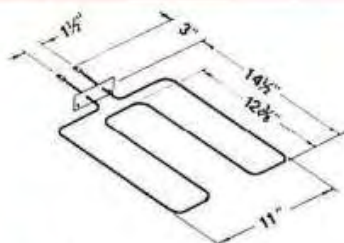
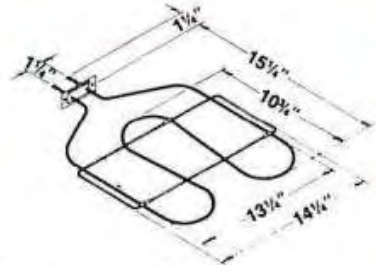
<p>CH660 453202</p>  <p>Tappan 221L003P01 221L003P03</p> <p>WATTS 2200 VOLTS 250</p>	<p>CH665 453253</p>  <p>Tappan 221T010P02</p> <p>WATTS 1500 VOLTS 120</p>	<p>CH672 455857</p>  <p>Gaffers & Sattler 332-5 Magic Chef West 332-191; 332-201; 332-202; 332-203</p> <p>WATTS 2400 VOLTS 250</p>
<p>CH661 453211</p>  <p>Tappan 221T009P01</p> <p>WATTS 2000 VOLTS 250</p>	<p>CH667 450618</p>  <p>Norge 41-4677 41-5667</p> <p>WATTS 3600 VOLTS 260</p>	<p>CH673 453683</p>  <p>Philco 3204-40</p> <p>WATTS 2500 VOLTS 250</p>
<p>CH662 453229</p>  <p>Tappan 221T011P01</p> <p>WATTS 3200 VOLTS 250</p>	<p>CH670 453261</p>  <p>Admiral 42491 Tappan 220T008P01; 220T008P05</p> <p>WATTS 1650 VOLTS 250</p>	<p>CH675 454432</p>  <p>Westinghouse Q26093; Q26127; Q26137; Q83516; Q134491; Q210811</p> <p>WATTS 1900 VOLTS 250</p>
<p>CH664 453245</p>  <p>Tappan 221T010P01; 221T010P04</p> <p>WATTS 1500 VOLTS 250</p>	<p>CH671 453270</p>  <p>Admiral 42413 Tappan 220T007P01; 220T010P04; 220T017P01</p> <p>WATTS 3000 VOLTS 250</p>	<p>CH676 453747</p>  <p>Westinghouse Q132331; Q132332; Q132336; Q210931</p> <p>WATTS 2800 VOLTS 250</p>



Backer

Bake & Broil Elements

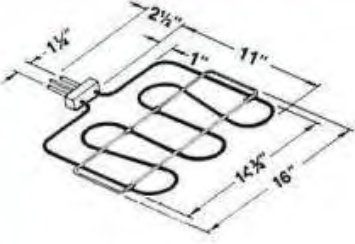
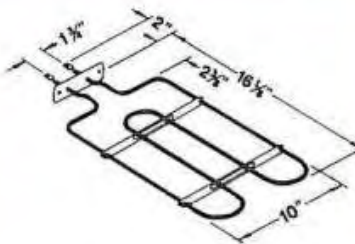
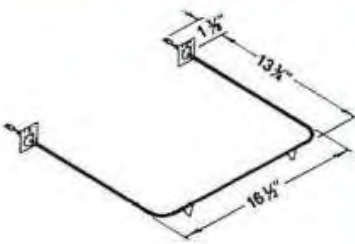
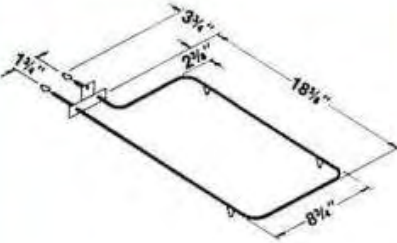
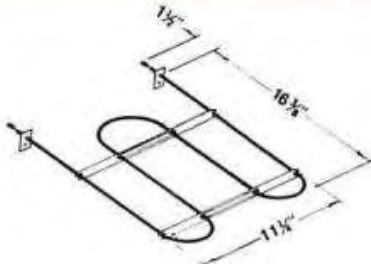
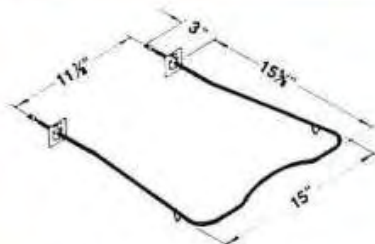
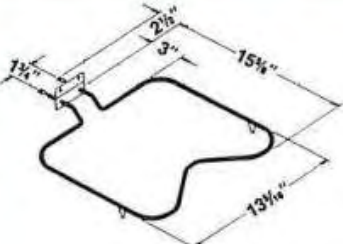
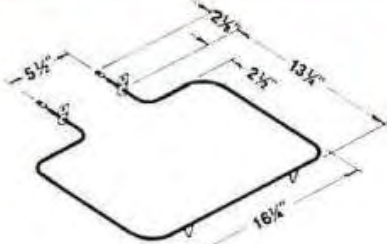
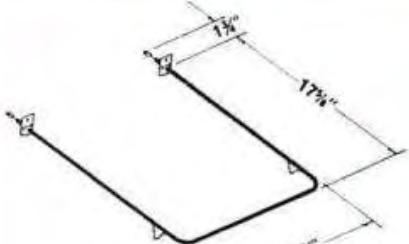
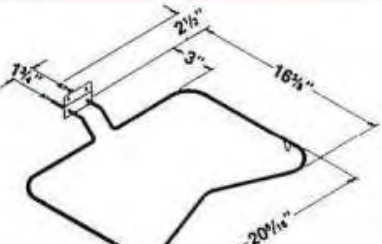
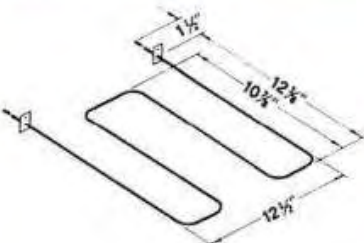
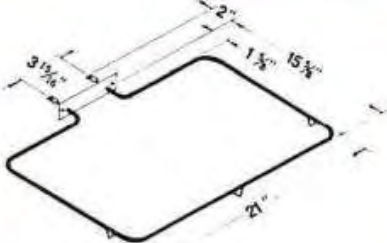
<p>CH677 454555</p>  <p>Westinghouse Q13951; Q13953; Q210751 WATTS 3200 VOLTS 250</p>	<p>CH681 454563</p>  <p>Brown 184-2E1 WATTS 2600 VOLTS 240</p>	<p>CH685 453798</p>  <p>Monarch WATTS 2000 VOLTS 240</p>
<p>CH678 455005</p>  <p>Columbus 0186-03 WATTS 1500 VOLTS 120</p>	<p>CH682 454571</p>  <p>Brown 184-2E7 WATTS 2600 VOLTS 240</p>	<p>CH687 453721</p>  <p>Whirlpool 255103; 257376; 257987; 326791 Roper 326791 WATTS 2200 VOLTS 250</p>
<p>CH679 453819</p>  <p>Brown 184-2E30; 184-2E37 WATTS 2000 VOLTS 240</p>	<p>CH683 454580</p>  <p>Sunray WATTS 2500 VOLTS 250</p>	<p>CH691 453288</p>  <p>Tappan 221T004P07 WATTS 2200 VOLTS 250</p>
<p>CH680 453827</p>  <p>Brown 184-2E28; 184-2E36 WATTS 2600 VOLTS 240</p>	<p>CH684 453755</p>  <p>Monarch WATTS 2400 VOLTS 240</p>	<p>CH693 453296</p>  <p>Tappan 221L006P01 WATTS 3000 VOLTS 250</p>



Backer



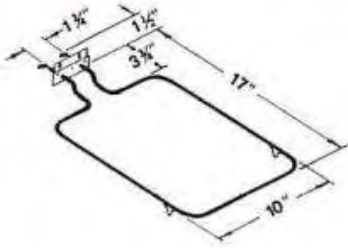
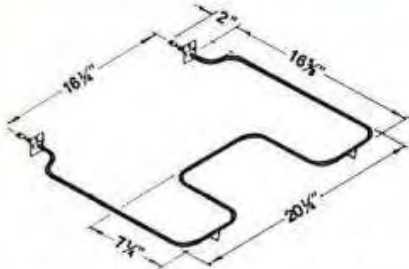
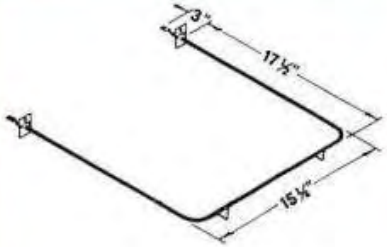
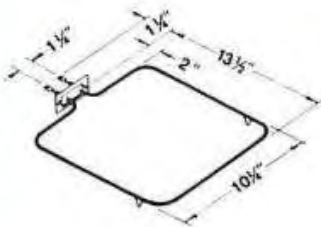
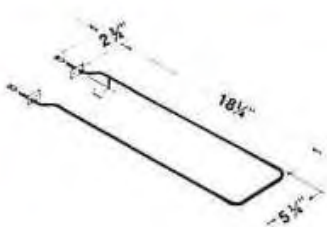
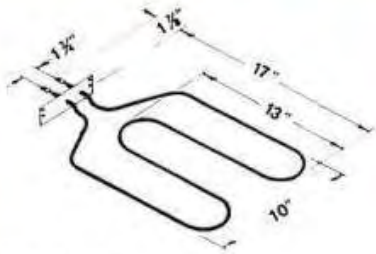
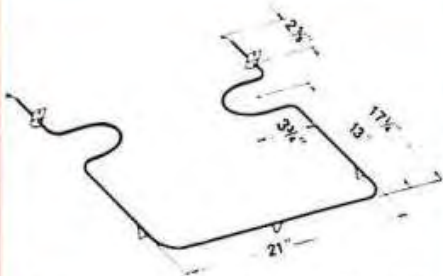
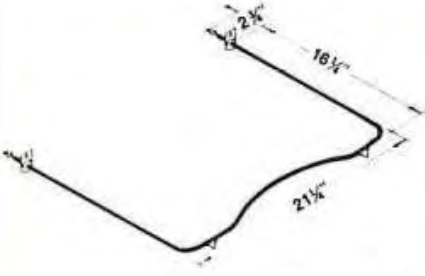
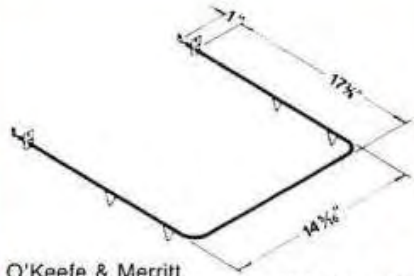
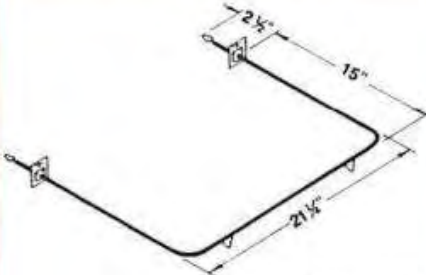
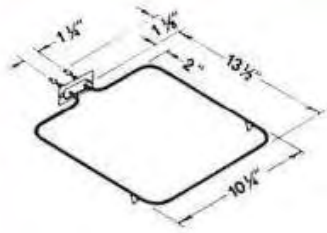
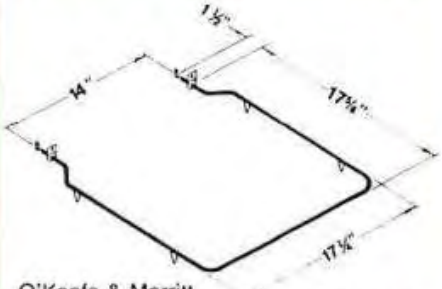

Bake & Broil Elements

<p>CH694 453801</p>  <p>Enterprise 150614</p> <p>WATTS 1600 VOLTS 240</p>	<p>CH698 453317</p>  <p>Hardwick OE-001-031-00; OE-001-031-99</p> <p>WATTS 3000 VOLTS 250</p>	<p>CH707 453763</p>  <p>Enterprise 150616</p> <p>WATTS 2200 VOLTS 240</p>
<p>CH695 454299</p>  <p>Frigidaire 633112; 7526493; 7526494; 7532554; 7532555</p> <p>WATTS 1600 VOLTS 240</p>	<p>CH699 453325</p>  <p>Hardwick OE-002-021-99</p> <p>WATTS 1700 VOLTS 240</p>	<p>CH708 454627</p>  <p>Magic Chef 106-153M; 106-157M; 1938-280; 1938-302</p> <p>WATTS 2700 VOLTS 250</p>
<p>CH696 453309</p>  <p>Modern Maid 74-06-133; 74-06-150</p> <p>WATTS 3000 VOLTS 250</p>	<p>CH700 453333</p>  <p>Roper/Kenmore 277543</p> <p>WATTS 2500 VOLTS 250</p>	<p>CH709 454635</p>  <p>O'Keefe & Merritt 221L003P05 Tappan 221L003P05</p> <p>WATTS 2000 VOLTS 250</p>
<p>CH697 454803</p>  <p>Wizard</p> <p>WATTS 2200 VOLTS 240</p>	<p>CH705 454619</p>  <p>Frigidaire 7526493</p> <p>WATTS 1600 VOLTS 240</p>	<p>CH710 454310</p>  <p>O'Keefe & Merritt 221L004P01 Tappan 221L004P01</p> <p>WATTS 2400 VOLTS 240</p>

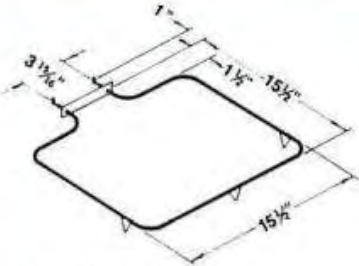
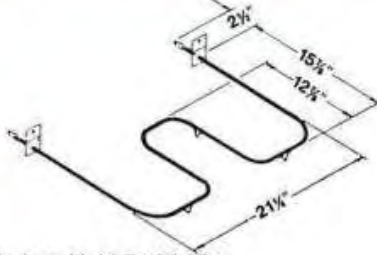
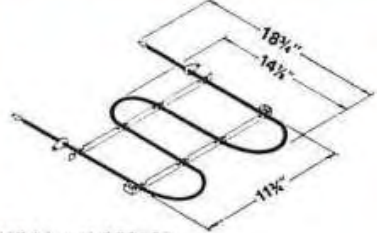
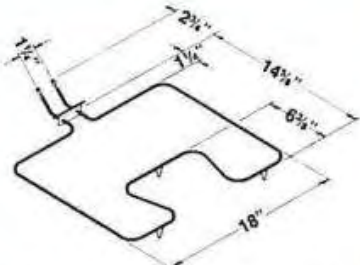
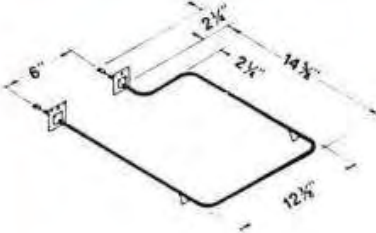

Backer

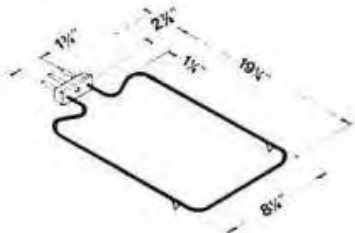
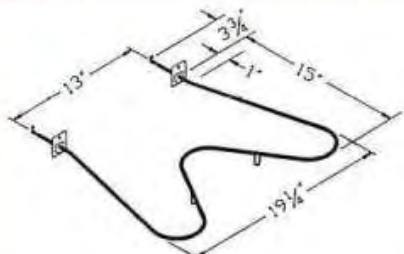
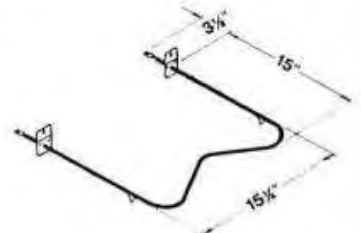
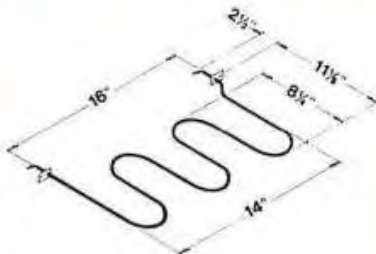
Bake & Broil Elements

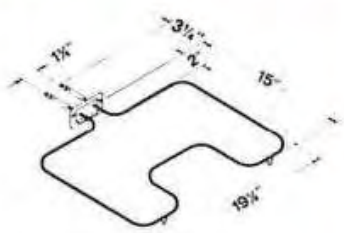
<p>CH712 454651</p>  <p>Tappan 221L007P01 O'Keefe & Merritt 221L007P01</p> <p>WATTS 2500 VOLTS 250</p>	<p>CH761 456075</p>  <p>Modern Maid 74-06-171; 74-06-162; 74-06-229; 74-06-230 Litton 96040</p> <p>WATTS 3000 VOLTS 240</p>	<p>CH779 455996</p>  <p>Whirlpool 258107; 261965; 308129; 311713; 311714; 311715; 311716; 312308</p> <p>WATTS 3000/2255 VOLTS 240/208</p>
<p>CH713 454660</p>  <p>Westinghouse Q138731; Q138732; Q210991</p> <p>WATTS 3000 VOLTS 250</p>	<p>CH764 453341</p>  <p>Magic Chef 106A-640W 106A-520F; 1938-204</p> <p>WATTS 1600 VOLTS 240</p>	<p>CH780 456008</p>  <p>Enterprise 150617; 150621</p> <p>WATTS 2500 VOLTS 250</p>
<p>CH714 456040</p>  <p>Gaffers & Sattler 332-12</p> <p>WATTS 2000 VOLTS 250</p>	<p>CH775 455988</p>  <p>Kelvinator/Kenmore 1312853; 1311298-D Whirlpool 865940</p> <p>WATTS 2400/1800 VOLTS 240/208</p>	<p>CH781 456016</p>  <p>Enterprise 150618; 150622</p> <p>WATTS 2000 VOLTS 250</p>
<p>CH759 455873</p>  <p>Modern Maid 74-06-156</p> <p>WATTS 2500 VOLTS 250</p>	<p>CH776 456091</p>  <p>Roper 282717; 301471; 314620; 319529; 319837; 320421; 320424; 324187; Kenmore 282717; 301471; 314620; 319529; 319837; 319838; 320421; 324186; 320420</p> <p>WATTS 2500 VOLTS 240</p>	<p>CH783 456622</p>  <p>Frigidaire 1133052; 632307; 632308; 7531230; 7531825; 9950886</p> <p>WATTS 3350/2330 VOLTS 250/208</p>



Backer

Bake & Broil Elements

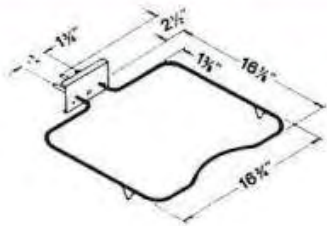
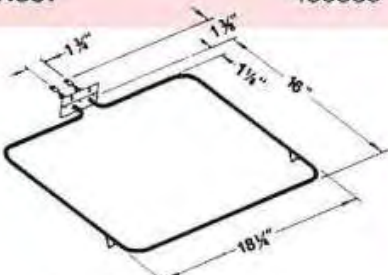
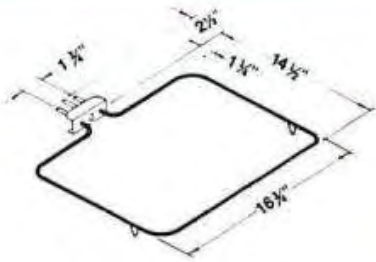
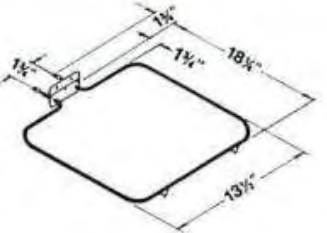
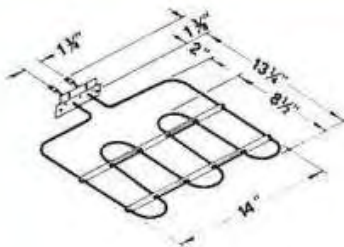
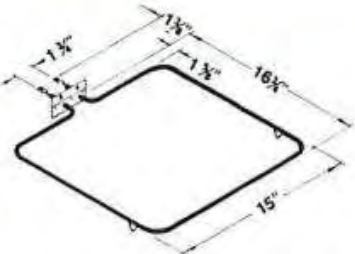
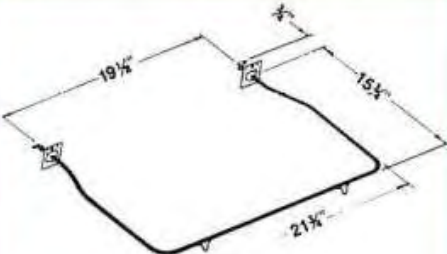
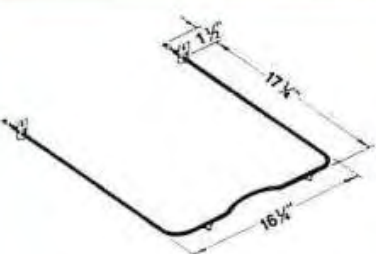
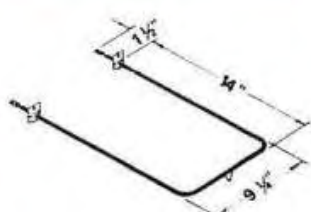
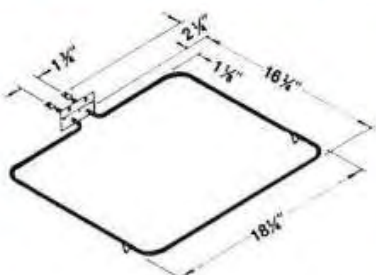
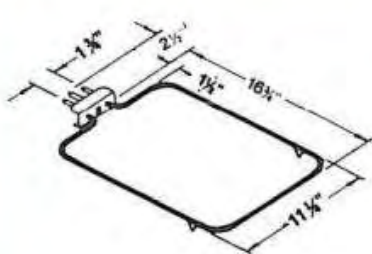
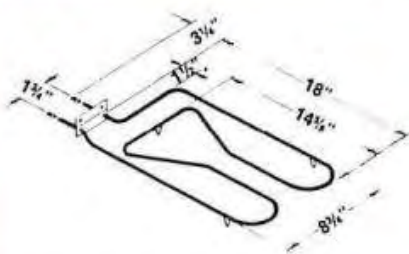
<p>CH802 456147</p>  <p>Thermador 14-09-639; 14-09-466A WATTS 2700 VOLTS 240</p>	<p>CH807 450589</p>  <p>Athens (Vesta) P-141-08 Whirlpool 263035 Kenmore 5321; 34155; 35499; 37691 WATTS 2400 VOLTS 240</p>	<p>CH811 453413</p>  <p>Kenmore 27374 WATTS 2000 VOLTS 240</p>
<p>CH803 456112</p>  <p>Welbilt Waste King WATTS 2300 VOLTS 240</p>	<p>CH808 452111</p>  <p>Kenmore 38078; 39296 WATTS 3000 VOLTS 240</p>	<p>CH812 453421</p>  <p>Kenmore 38463 WATTS 2000 VOLTS 240</p>
<p>CH805 453350</p>  <p>RCA-Whirlpool 268766 Whirlpool 261529; 270401 WATTS 2600 VOLTS 240</p>	<p>CH809 450730</p>  <p>Roper/Kenmore 104787; 115037 WATTS 2000 VOLTS 240</p>	<p>CH813 450810</p>  <p>Roper/Kenmore 106699 WATTS 1500 VOLTS 240</p>
<p>CH806 453368</p>  <p>Kenmore 32890; 33350; 33351; 35004; 38232 WATTS 2400 VOLTS 250</p>	<p>CH810 453405</p>  <p>Plug-In Bake Kenmore 27413 WATTS 1800 VOLTS 240</p>	<p>CH814 453430</p>  <p>Jenn-Air/Roper/Kenmore 109305; 239119; 302249 Roper/Kenmore 319842 WATTS 1800 VOLTS 240</p>



Backer



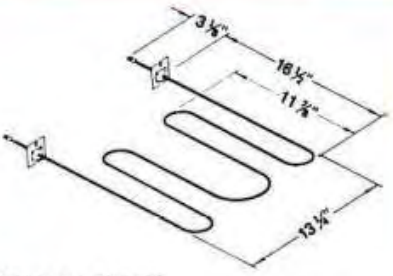
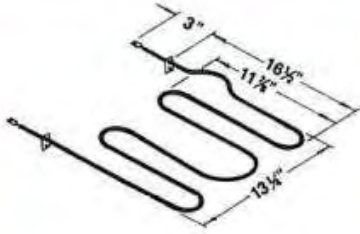
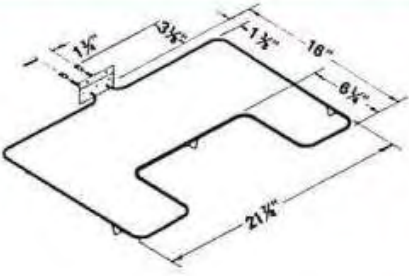
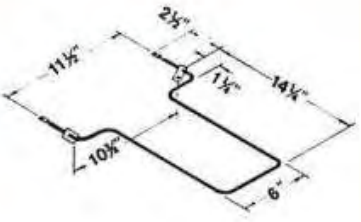
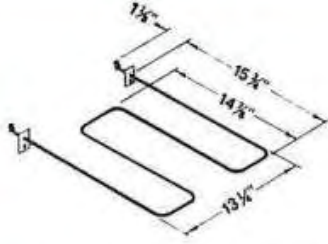
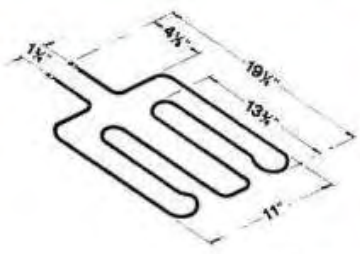
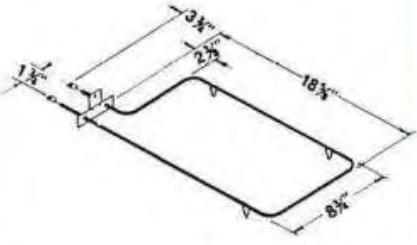
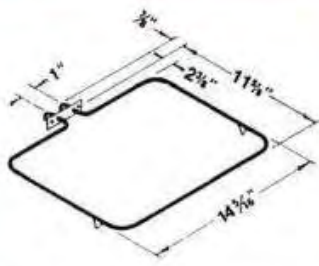
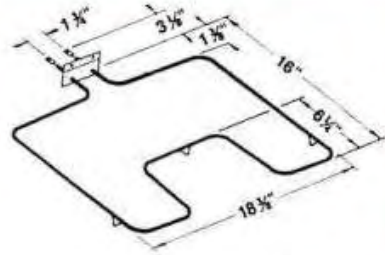
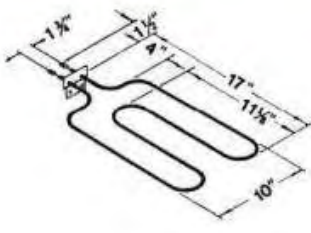
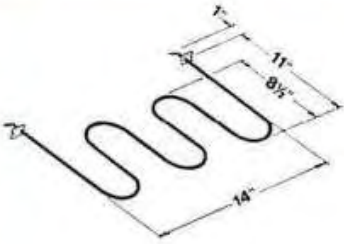
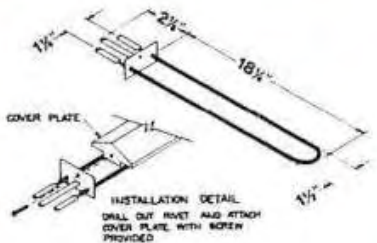

Bake & Broil Elements

<p>CH815 453448</p>  <p>Whirlpool 241472 Kelvinator/Kenmore 1303580</p> <p>WATTS 3400 VOLTS 240</p>	<p>CH821 453464</p>  <p>Kelvinator/Kenmore 1303582</p> <p>WATTS 3400 VOLTS 240</p>	<p>CH956 450520</p>  <p>Norge 41-5956</p> <p>WATTS 3000 VOLTS 250</p>
<p>CH816 453595</p>  <p>Columbus C-853-001</p> <p>WATTS 1500 VOLTS 240</p>	<p>CH824 454790</p>  <p>Kelvinator 1188746; 1188747</p> <p>WATTS 3000 VOLTS 250</p>	<p>CH957 456180</p>  <p>Thermador</p> <p>WATTS 3600 VOLTS 250</p>
<p>CH818 453456</p>  <p>Columbus C-186-04</p> <p>WATTS 1500 VOLTS 240</p>	<p>CH825 453771</p>  <p>Modern Maid 74-6-148; 74-6-166; 74-6-208</p> <p>WATTS 1750 VOLTS 250</p>	<p>CH958 450511</p>  <p>Norge 41-5958</p> <p>WATTS 2600 VOLTS 240</p>
<p>CH820 454686</p>  <p>Enterprise 150513; 150522</p> <p>WATTS 2400 VOLTS 240</p>	<p>CH826 455865</p>  <p>Modern Maid 74-06-136</p> <p>WATTS 2500 VOLTS 250</p>	<p>CH959 456155</p>  <p>Frigidaire 2549818</p> <p>WATTS 1400 VOLTS 240</p>

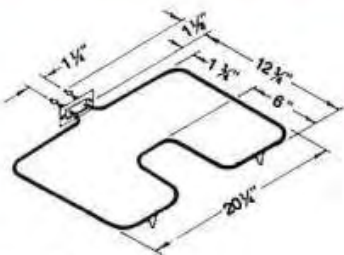
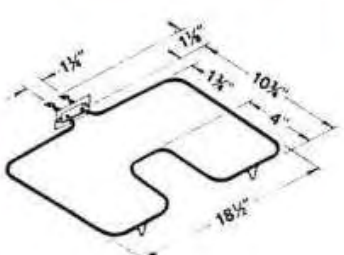
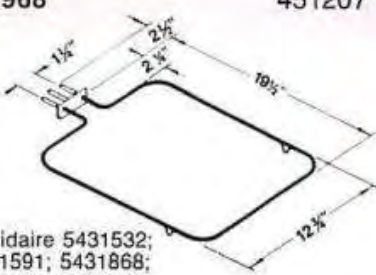
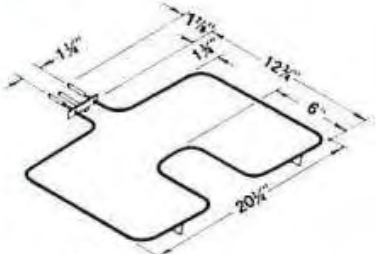
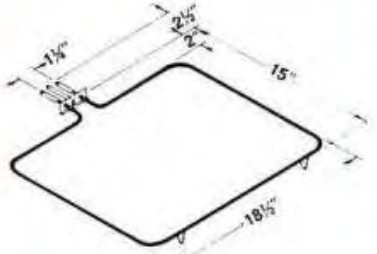
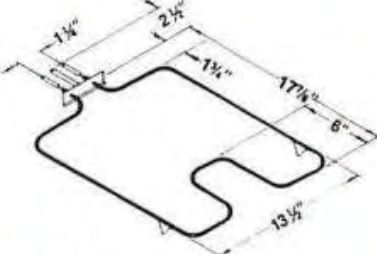

Backer

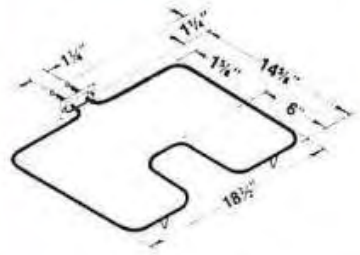
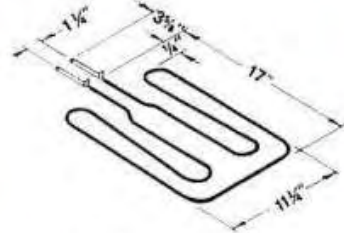
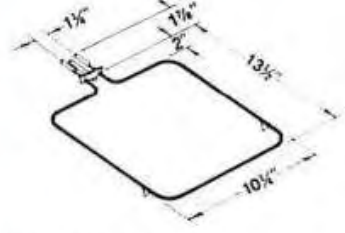
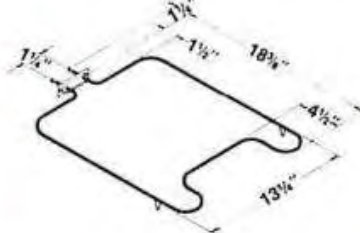
Bake & Broil Elements

<p>CH960 454344</p>  <p>Frigidaire 633110; 7526489; 7532552; 7532553</p> <p>WATTS 2400 VOLTS 240</p>	<p>CH964 454379</p>  <p>Frigidaire 1133272; 7526005; 7532550</p> <p>WATTS 2250 VOLTS 250</p>	<p>CH968 451207</p>  <p>Frigidaire 5431532; 5431591; 5431868; 5432061; 5432062; 5432063; 5432675; 5432679; 5432683; 5432976; 5439601; 5439827</p> <p>WATTS 2000 VOLTS 240</p>
<p>CH961 454352</p>  <p>Frigidaire 6564632; 7520969; 7521393; 7521397</p> <p>WATTS 2400 VOLTS 240</p>	<p>CH965 454387</p>  <p>Frigidaire 7532223</p> <p>WATTS 2200 VOLTS 240</p>	<p>CH969 454125</p>  <p>Frigidaire 6561553; 7524069; 7533577; 9950891</p> <p>WATTS 2700 VOLTS 250</p>
<p>CH962 454694</p>  <p>Frigidaire 7531325; 7525588; 7527198; 7531324; 7525606; 7526592; 7526594; 7531326</p> <p>WATTS 3600 VOLTS 240</p>	<p>CH966 454109</p>  <p>Frigidaire 7525864; 7526610; 9950890</p> <p>WATTS 2700 VOLTS 250</p>	<p>CH970 454133</p>  <p>Frigidaire 5439369; 5439402; 6560890; 6560891; 7524685; 7524686</p> <p>WATTS 3600 VOLTS 240</p>
<p>CH963 454360</p>  <p>Frigidaire 6564694; 7520991; 7521900; 7521905</p> <p>WATTS 1600 VOLTS 240</p>	<p>CH967 454117</p>  <p>Frigidaire 7525867; 7526605; 9950889</p> <p>WATTS 2800 VOLTS 250</p>	<p>CH971 454141</p>  <p>Frigidaire 6563765; 6564391; 7523774; 7524073; 7524074; 7525622; 7525629; 7526298; 7526597; 7526598; 7526601; 7531329; 7531806; 7531869</p> <p>WATTS 3600 VOLTS 240</p>



Backer

Bake & Broil Elements

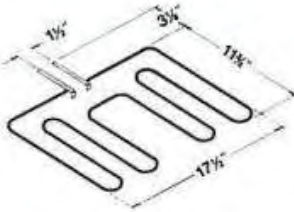
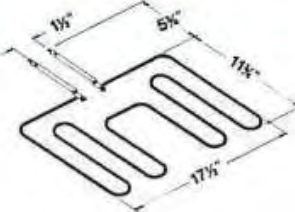
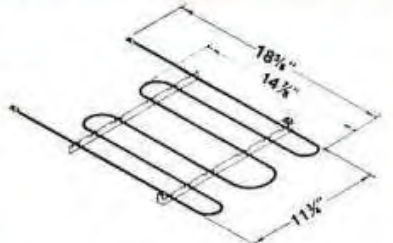
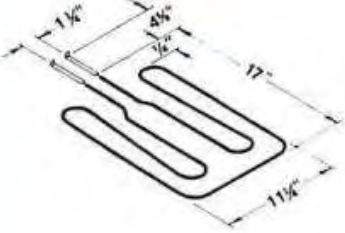
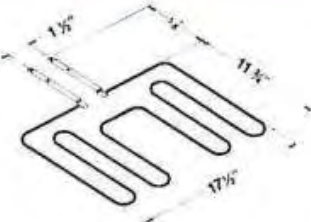
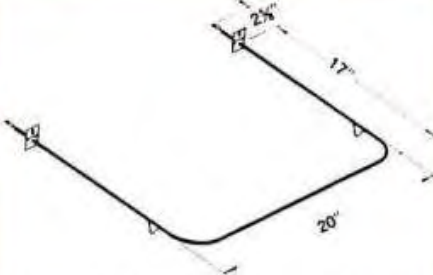
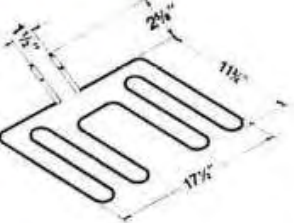
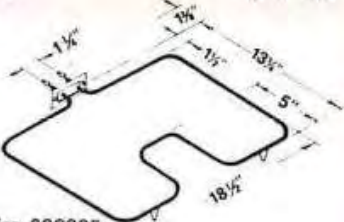
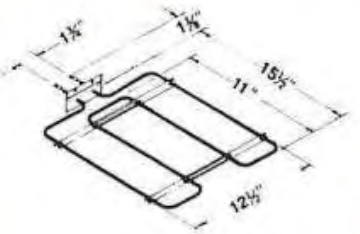
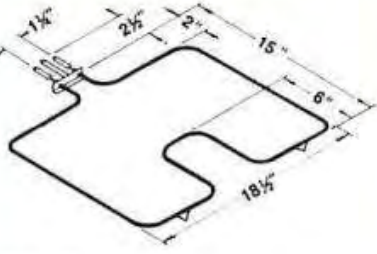
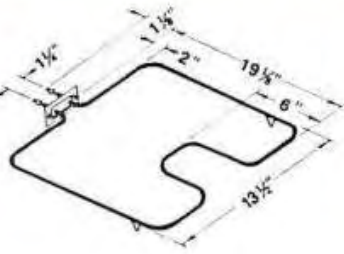
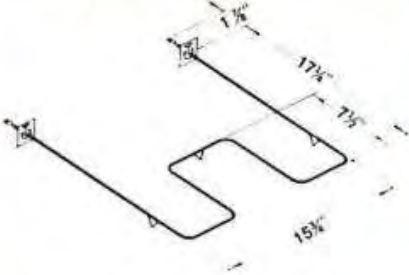
<p>CH972 454395</p>  <p>Frigidaire 5439493; 7524680; 5432263; 5439497; 5439572</p> <p>WATTS 3600 VOLTS 240</p>	<p>CH976 454723</p>  <p>Frigidaire 6563301; 7531340; 7524681; 7524682; 7523839; 7531226</p> <p>WATTS 3600 VOLTS 240</p>	<p>CH987 453472</p>  <p>Whirlpool 256844; 257367; 265620; 265622; 326795 Roper 326795</p> <p>WATTS 3500 VOLTS 250</p>
<p>CH973 454707</p>  <p>Frigidaire 6562551; 7524688</p> <p>WATTS 3600 VOLTS 240</p>	<p>CH977 454731</p>  <p>Frigidaire 7522760; 7524684; 7524683</p> <p>WATTS 3600 VOLTS 240</p>	<p>CH1001 450790</p>  <p>Columbus C-241-2; C-241-3</p> <p>WATTS 2500 VOLTS 240</p>
<p>CH974 454715</p>  <p>Frigidaire 6564765</p> <p>WATTS 3600 VOLTS 240</p>	<p>CH978 454150</p>  <p>Frigidaire 632305; 632306; 633114; 1133051; 7525769; 7525781; 7526491; 7526492; 7526602; 7532556; 7532557; 8004202; 9950885</p> <p>WATTS 2475 VOLTS 250</p>	<p>CH1003 451741</p>  <p>Kenmore 45596; 243946</p> <p>WATTS 3000 VOLTS 240</p>
<p>CH975 451127</p>  <p>Frigidaire 6560769; 6562584; 6564003; 7524691; 9950888</p> <p>WATTS 2700 VOLTS 250</p>	<p>CH979 454168</p>  <p>Frigidaire 634706; 7525706; 7526607</p> <p>WATTS 2700 VOLTS 250</p>	<p>CH1004 450870</p>  <p>Chambers 7568-D</p> <p>WATTS 3000 VOLTS 250</p>



Backer

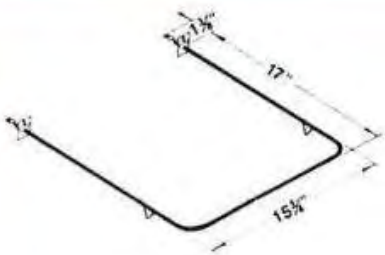
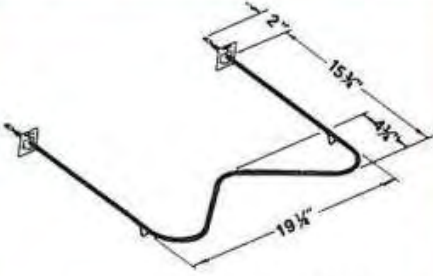
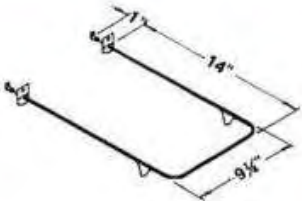
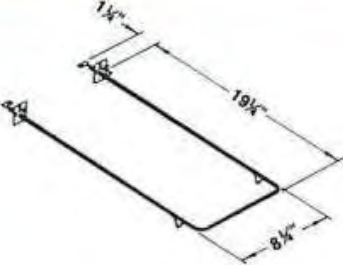
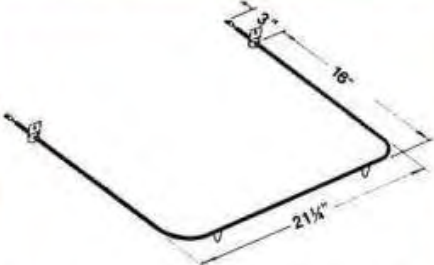
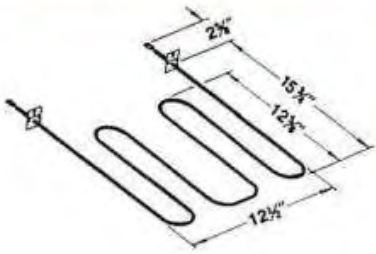
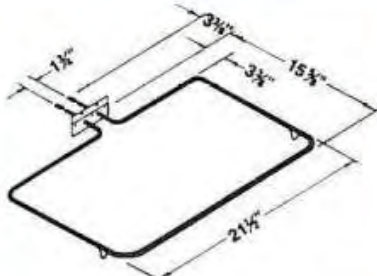
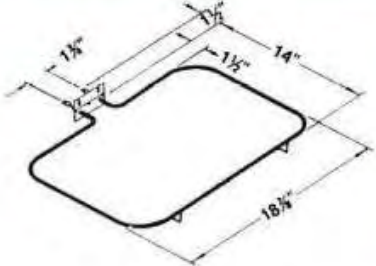
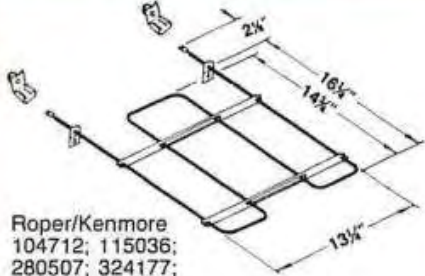
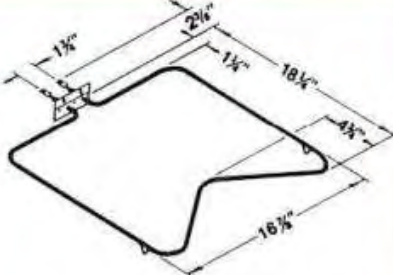
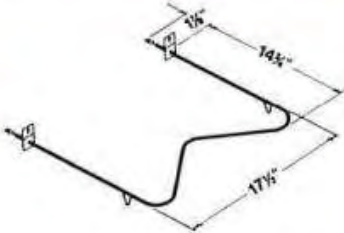
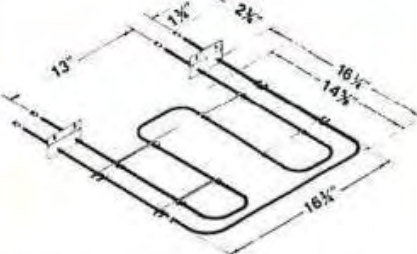

Bake & Broil Elements

<p>CH1005 450802</p>  <p>Hardwick OE-001-002-00</p> <p>WATTS 2000 VOLTS 240</p>	<p>CH1011 450861</p>  <p>Philco 3204-33</p> <p>WATTS 2500 VOLTS 240</p>	<p>CH1016 450706</p>  <p>O'Keefe & Merritt 221L002P01</p> <p>WATTS 1500 VOLTS 250</p>
<p>CH1006 452200</p>  <p>Modern Maid 74-6-62</p> <p>WATTS 2000 VOLTS 240</p>	<p>CH1012 450722</p>  <p>Roper/Kenmore 104711</p> <p>WATTS 2500 VOLTS 250</p>	<p>CH1019 451805</p>  <p>Nutone C-28078</p> <p>WATTS 3600 VOLTS 240</p>
<p>CH1009 450600</p>  <p>Nutone D-29458</p> <p>WATTS 3000 VOLTS 250</p>	<p>CH1014 450597</p>  <p>Roper/Kenmore 106618</p> <p>WATTS 1800 VOLTS 240</p>	<p>CH1020 453499</p>  <p>Roper/Kenmore 104712; 115036; 280507; 324177; 324178; 520519 Roper 1250-14; 320518</p> <p>WATTS 2250/3000 VOLTS 208/240</p>
<p>CH1010 450503</p>  <p>Nutone C-28077</p> <p>WATTS 2500 VOLTS 240</p>	<p>CH1015 450765</p>  <p>Sunray Stove 03000; 03000-04; 74098-02</p> <p>WATTS 2400 VOLTS 250</p>	<p>CH1024 453510</p>  <p>Kenmore/Roper 229118; 235297</p> <p>WATTS 2600/3600 VOLTS 240</p>



Backer

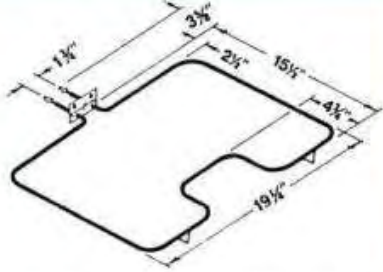
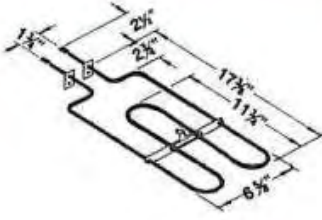
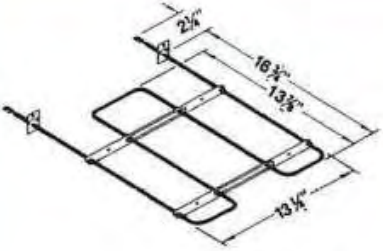
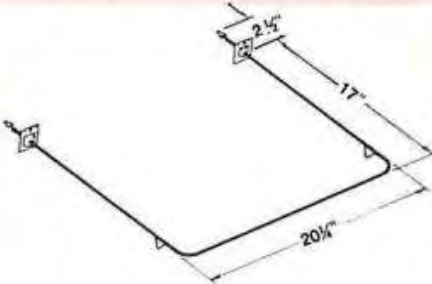
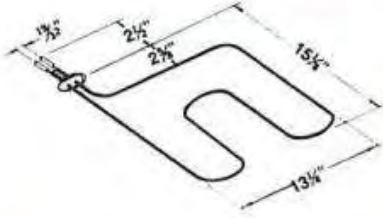
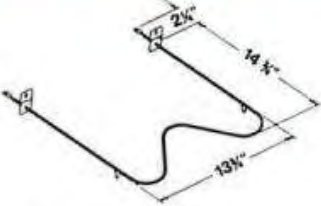
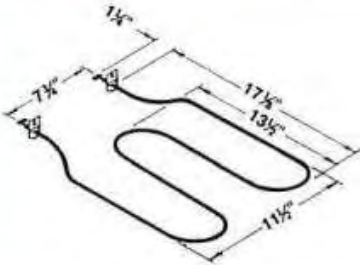
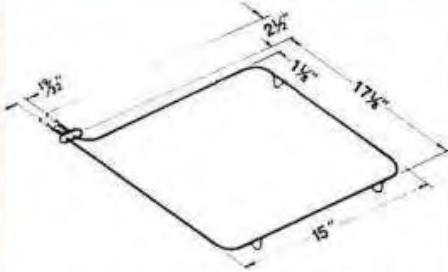
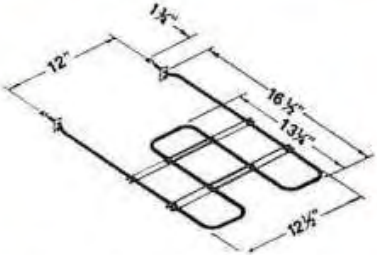

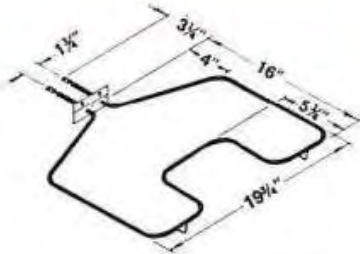
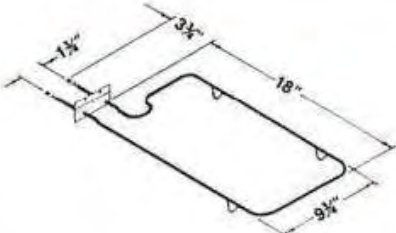

Bake & Broil Elements

<p>CH1025 453528</p>  <p>Roper/Kenmore 282730 WATTS 3200 VOLTS 240</p>	<p>CH1029 453561</p>  <p>Roper/Kenmore 1308773; 1310236 WATTS 1500 VOLTS 240</p>	<p>CH1036 453632</p>  <p>Gray & Dudley C-8477 WATTS 3000 VOLTS 250</p>
<p>CH1026 453536</p>  <p>Roper/Kenmore 630718 WATTS 2200 VOLTS 240</p>	<p>CH1030 453579</p>  <p>Athens (Vesta) P-141-23 Kenmore 6337 WATTS 3000 VOLTS 250</p>	<p>CH1037 453641</p>  <p>Gray & Dudley 8743; C-8478; 1533 Enterprise 150610; 150624 WATTS 2000 VOLTS 240</p>
<p>CH1027 453544</p>  <p>Kenmore/Preway K-11581 WATTS 3000 VOLTS 240</p>	<p>CH1031 453587</p>  <p>Athens (Vesta) P-141-20 Kenmore 6707 WATTS 2000 VOLTS 240</p>	<p>CH1039 453667</p>  <p>Hardwick OE-002-013-99 OE-002-163-99 WATTS 2800 VOLTS 240</p>
<p>CH1028 453552</p>  <p>Athens (Vesta) P-141-22 Kenmore 6336 WATTS 2400 VOLTS 240</p>	<p>CH1035 453624</p>  <p>Corning 981034 WATTS 3000 VOLTS 250</p>	<p>CH1040 453675</p>  <p>Kelvinator 1303549 WATTS 1500 VOLTS 240</p>

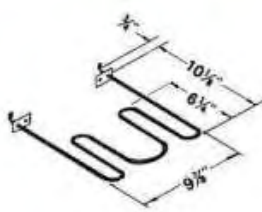
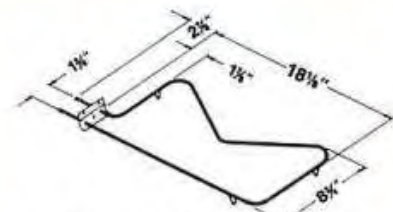
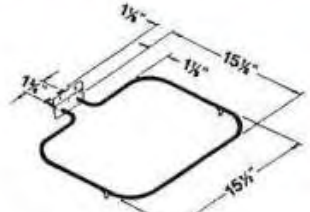
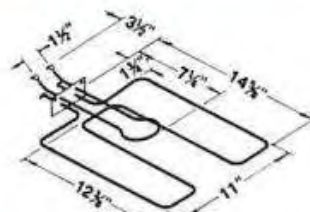
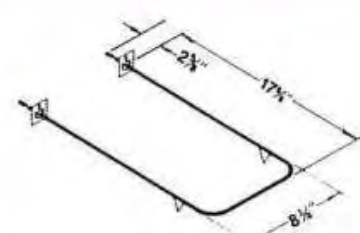

Backer

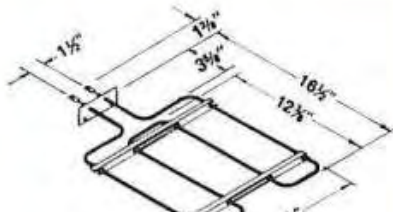
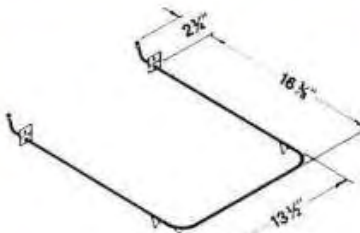

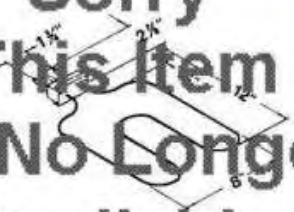
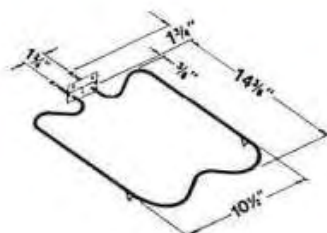
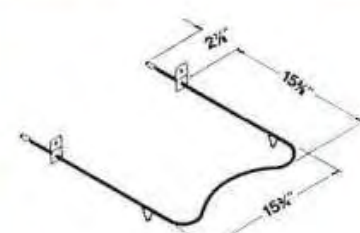



Bake & Broil Elements

<p>CH1042 453691</p>  <p>Tappan 220T008P02</p> <p>WATTS 1650 VOLTS 120</p>	<p>CH1840 454408</p>  <p>Sunray Stove 07398; 07398-04; 74102-00; 7498-004; Kelvinator 1301720 Gray & Dudley C-3125</p> <p>WATTS 1500 VOLTS 240</p>	<p>CH2822 456083</p>  <p>Magic Chef 106A-1910M; 1938-227</p> <p>WATTS 2000 VOLTS 240</p>
<p>CH1043 453704</p>  <p>Tappan 220T011P01</p> <p>WATTS 325/2600 VOLTS 110/250</p>	<p>CH1858 453835</p>  <p>Brown 184-2E29</p> <p>WATTS 2200 VOLTS 240</p>	<p>CH2833 456243</p>  <p>Athens E-141-029 Kenmore 7622</p> <p>WATTS 2000 VOLTS 250</p>
<p>CH1044 453712</p>  <p>Tappan 03-233-9</p> <p>WATTS 2200 VOLTS 250</p>	<p>CH2817 454416</p>  <p>Magic Chef 106A-157M; 1938-276</p> <p>WATTS 1800 VOLTS 250</p>	<p>CH2835 456251</p>  <p>Athens E-141-031</p> <p>WATTS 2400 VOLTS 250</p>
<p>CH1815 453376</p> <p>Sorry This Item Is No Longer Available</p>  <p>Kenmore 38073</p> <p>WATTS 1500 VOLTS 240</p>	<p>CH2820 456067</p>  <p>Thermador 14-09-526</p> <p>WATTS 1650 VOLTS 240</p>	<p>CH2836 456260</p>  <p>Chambers 14114</p> <p>WATTS 2000/1500 VOLTS 240/208</p>

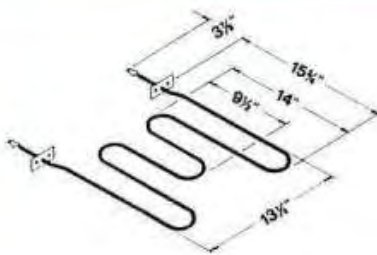
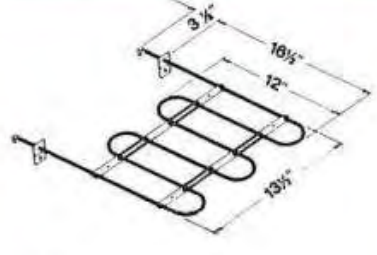
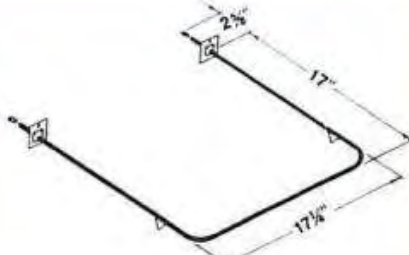

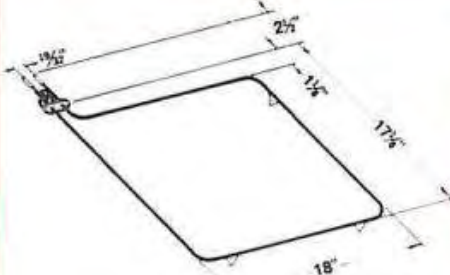
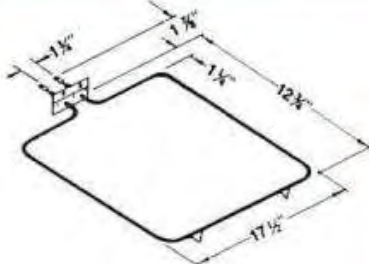
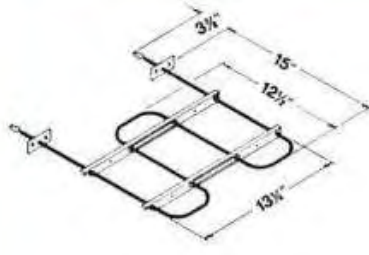
Backer

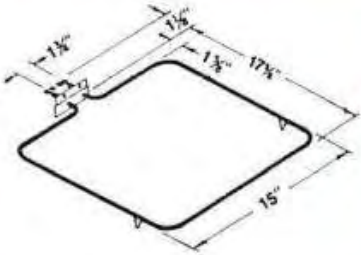
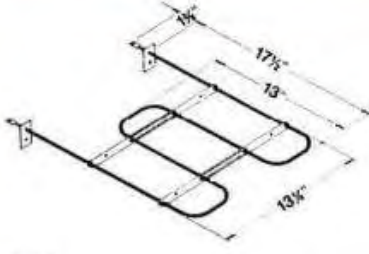

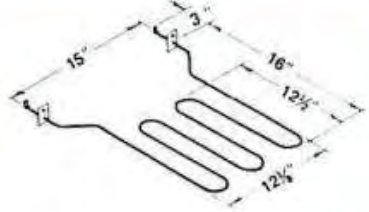
Bake & Broil Elements

<p>CH2837 456278</p>  <p>Chambers Q523-028 WATTS 2800/2100 Kenmore 22239 VOLTS 240/208</p>	<p>CH2842 456315</p>  <p>Hardwick OE-002-156-99; WATTS 3000/2250 OE-002-166-99 VOLTS 240/208</p>	<p>CH2847 454424</p>  <p>Roper/Kenmore 630719 WATTS 2200 VOLTS 240</p>
<p>CH2838 456286</p>  <p>Chambers Q523-029; Q523-032 WATTS 1800/1350 Kenmore 22238 VOLTS 240/208</p>	<p>CH2844 453851</p>  <p>Athens (Vesta) P-141-21 WATTS 2400 VOLTS 240</p>	<p>CH2848 454459</p>  <p>Athens (Vesta) P-141-16 WATTS 1700 VOLTS 240</p>
<p>CH2839 456294</p>  <p>Chambers Q523-031 WATTS 2800/2100 VOLTS 240/208</p>	<p>CH2845 456331</p>  <p>Hardwick OE-001-044-99 WATTS 1700/1275 OE-001-041-99 VOLTS 240/208 OE-001-032-99</p>	<p>CH2849 454969</p>  <p>Magic Chef 106A-1960M; WATTS 2500 1938-258 VOLTS 250</p>
<p>CH2840 456307</p>  <p>Hardwick OE-002-003-99; WATTS 3000/2250 OE-003-160-99 VOLTS 240/208</p>	<p>CH2846 456340</p>  <p>Hardwick OE-001-045-99; WATTS 1800/1350 OE-001-042-99; VOLTS 240/208 OE-001-016-99</p>	<p>CH2850 454977</p>  <p>Magic Chef 106-352M; 106-355M; 1938-299; WATTS 3100 1938-321 VOLTS 240</p>

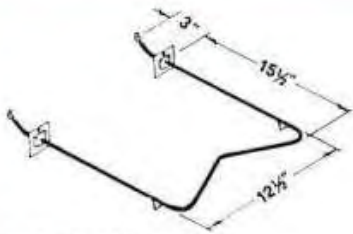
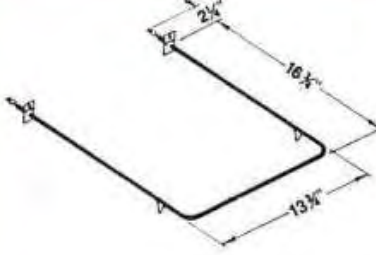
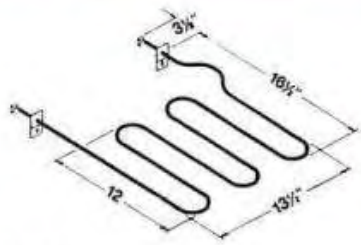
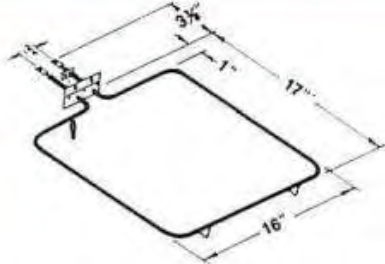

Backer

Bake & Broil Elements

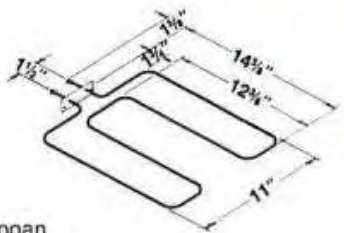
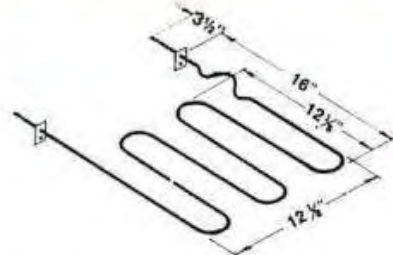
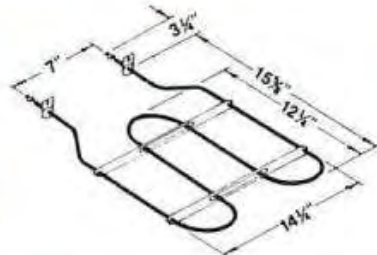
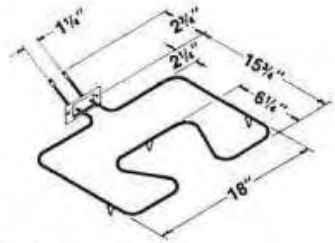
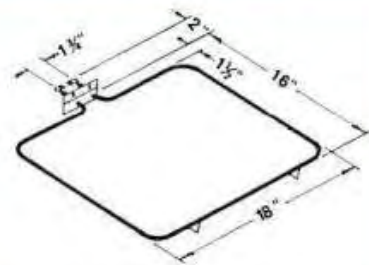
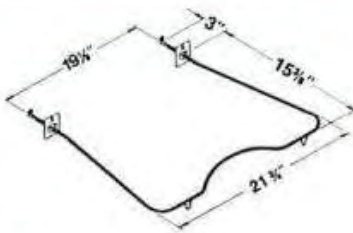
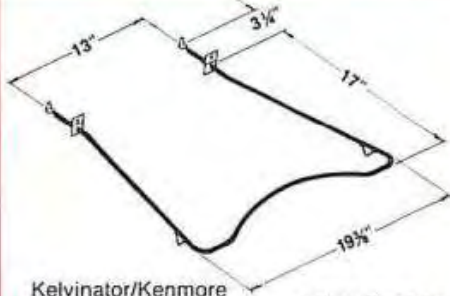
<p>CH2851 454854</p>  <p>Magic Chef 106A-153M; 106A-155M; 106A-15AM; 1938-296; 1938-326; 1938-364</p> <p>WATTS 2100 VOLTS 250</p>	<p>CH2857 454918</p>  <p>Gray & Dudley 1533</p> <p>WATTS 2000 VOLTS 240</p>	<p>CH2862 456358</p>  <p>Hardwick OE-002-168-99; OE-002-159-99</p> <p>WATTS 3000/2250 VOLTS 240/208</p>
<p>CH2852 454862</p>  <p>Magic Chef 106A-973M; 1938-313</p> <p>WATTS 2600 VOLTS 240</p>	<p>CH2858 454926</p>  <p>Roper/Kenmore 296119; 296565; 301444; 321667</p> <p>WATTS 2700 VOLTS 240</p>	<p>CH2863 456200</p>  <p>Tappan 220T012P01; 220T012P03; 220T012P05; 220T017P02</p> <p>WATTS 3000/2077 VOLTS 250/208</p>
<p>CH2853 454870</p>  <p>Magic Chef 106-973M; 1938-312</p> <p>WATTS 2750 VOLTS 240</p>	<p>CH2859 454934</p>  <p>Roper/Kenmore 296121; 296566; 319487; 324163; 324249; 324251</p> <p>WATTS 3400 VOLTS 240</p>	<p>CH2864 455152</p>  <p>Westinghouse Q147363; Q147364; Q147366; Q207512; Q207513; Q207516</p> <p>WATTS 3000 VOLTS 250</p>
<p>CH2854 454889</p>  <p>Magic Chef 106A-2710F 1938-206</p> <p>WATTS 1800 VOLTS 250</p>	<p>CH2860 454820</p>  <p>Whirlpool 258978; 257988; 257368; 257057; 255104; 261966; 326793</p> <p>WATTS 2500/1875 VOLTS 240/208</p>	<p>CH2865 455179</p>  <p>Kelvinator/Kenmore 1303562; 1307474 Whirlpool 834679</p> <p>WATTS 2400 VOLTS 240</p>



Backer

Bake & Broil Elements

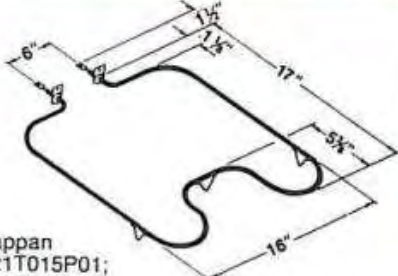
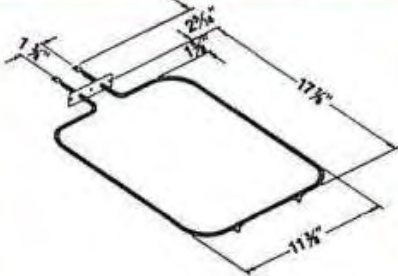
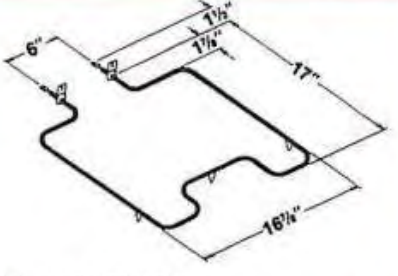
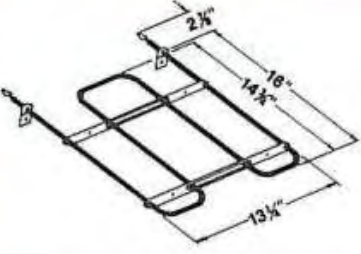
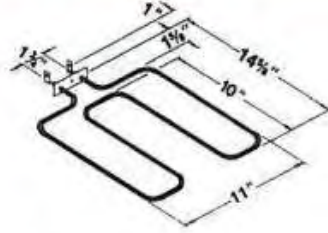
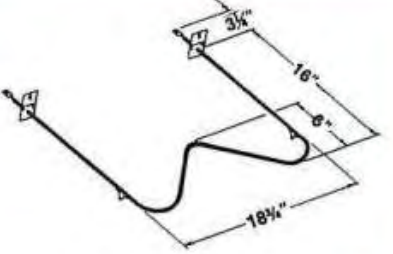
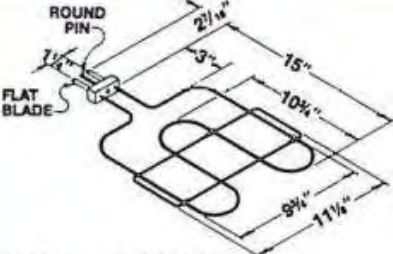
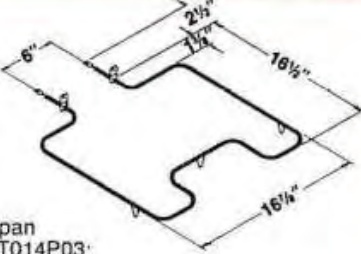
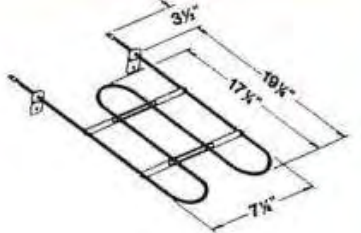
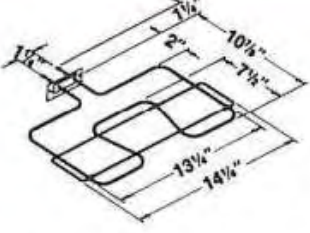
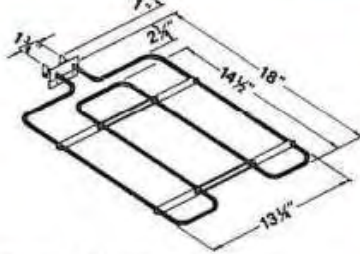
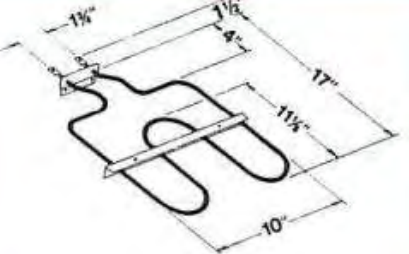
<p>CH2866 455080</p>  <p>Tappan 221T015P01; 221T015P03; 221T015P05; 221T021P01</p> <p>WATTS 2000/1384 VOLTS 250/208</p>	<p>CH2870 455101</p>  <p>Dwyer 925-012; KA-90T</p> <p>WATTS 2250 VOLTS 208</p>	<p>CH2874 455144</p>  <p>Tappan 221T014P01; 221T014P05; 221T014P08</p> <p>WATTS 2000/1384 VOLTS 250/208</p>
<p>CH2867 455072</p>  <p>Kenmore 232185 Roper 232185</p> <p>WATTS 3600 VOLTS 250</p>	<p>CH2871 455110</p>  <p>Tappan 220L007P01 O'Keefe & Merritt 220L007P01</p> <p>WATTS 3000/2077 VOLTS 250/208</p>	<p>CH2876 455160</p>  <p>Hardwick OE-001-038-99; OE-001-048-99</p> <p>WATTS 2400 VOLTS 240</p>
<p>CH2868 456198</p>  <p>Westinghouse Q25976; Q25979; Q26001; Q26002; Q83578; Q138251; Q210821</p> <p>WATTS 2300 VOLTS 250</p>	<p>CH2872 455123</p>  <p>Tappan 221T014P03; 221T014P06; 221T014P09; 221T014P12; 221T014P13</p> <p>WATTS 2000/1500 VOLTS 240/208</p>	<p>CH2882 455881</p>  <p>Roper 109306; 239118; 319844</p> <p>WATTS 2500 VOLTS 240</p>
<p>CH2869 455099</p>  <p>Westinghouse Q149801; Q149802; Q149803; Q210781; Q210782</p> <p>WATTS 2400 VOLTS 250</p>	<p>CH2873 455136</p>  <p>O'Keefe & Merritt 220L003P01 Tappan 220L003P01</p> <p>WATTS 3000 VOLTS 250</p>	<p>CH2885 455910</p>  <p>Enterprise 150514; 150514-B</p> <p>WATTS 1500 VOLTS 120</p>



Backer

Bake & Broil Elements

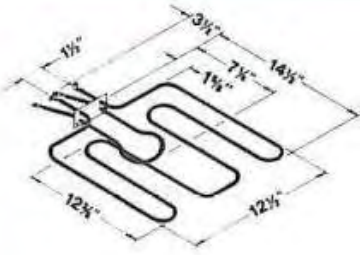
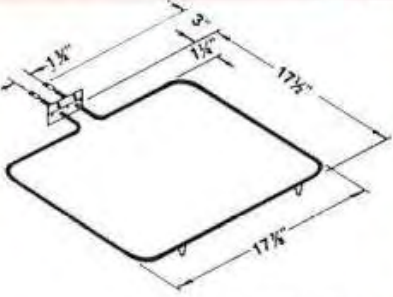
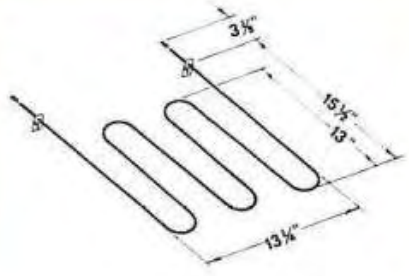
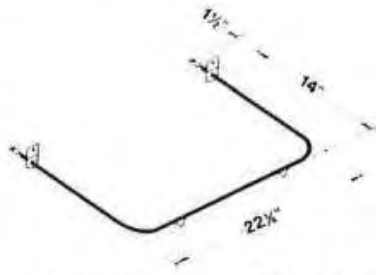
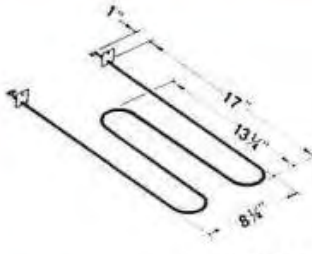
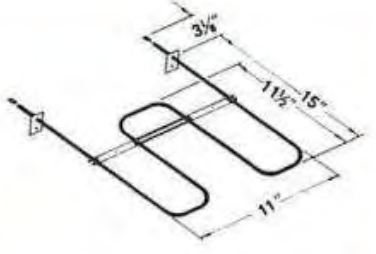
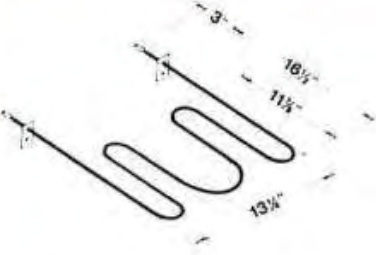
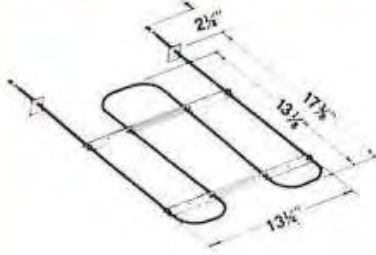
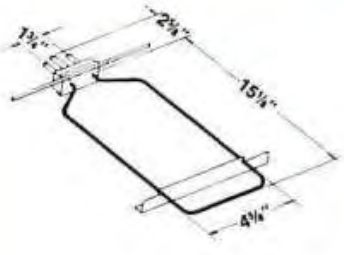
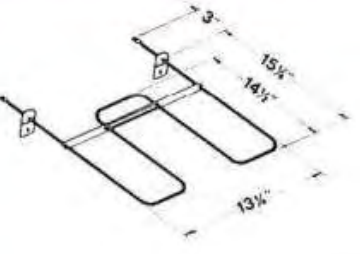
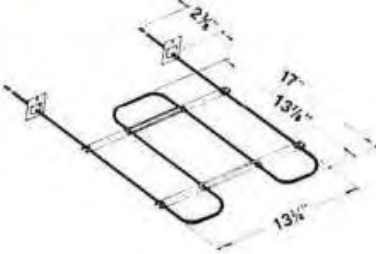
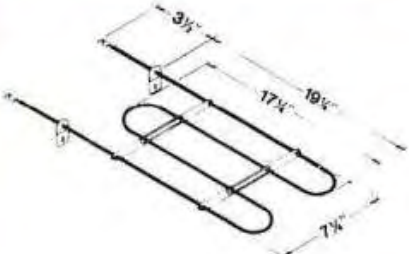
<p>CH2886 455929</p>  <p>Tappan 220T009P01 WATTS 325/3600 VOLTS 110/240</p>	<p>CH3800 454440</p>  <p>Enterprise 150613 WATTS 2800 VOLTS 240</p>	<p>CH3882 454230</p>  <p>Modern Maid 74-6-7 WATTS 3000 VOLTS 250</p>
<p>CH2889 455953</p>  <p>Kenmore/Roper 106037; 238154 WATTS 1800 VOLTS 240</p>	<p>CH3801 454467</p>  <p>Modern Maid 74-6-64 WATTS 3000 VOLTS 250</p>	<p>CH3887 454301</p>  <p>Enterprise 150515; 150516; 150519 WATTS 2700 VOLTS 240</p>
<p>CH2891 455970</p>  <p>Kelvinator 1310050-D Kenmore 1310050-D WATTS 3400 VOLTS 240</p>	<p>CH3805 454475</p>  <p>Enterprise 150609 WATTS 3000 VOLTS 250</p>	<p>CH4805 457748</p>  <p>Roper/Kenmore 71908 WATTS 1425 VOLTS 115</p>
<p>CH2899 456059</p>  <p>Eagle 58658 WATTS 3000 VOLTS 250</p>	<p>CH3839 454176</p>  <p>Roper/Kenmore 630720 WATTS 3500 VOLTS 240</p>	<p>CH4806 457625</p>  <p>Roper/Kenmore 113131; 293117; 319845 WATTS 2500 VOLTS 208</p>



Backer

Bake & Broil Elements

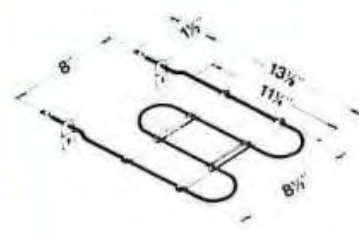
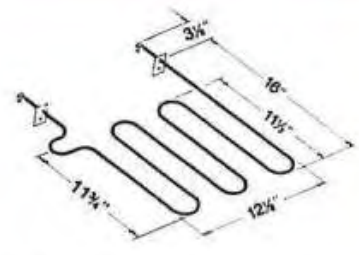
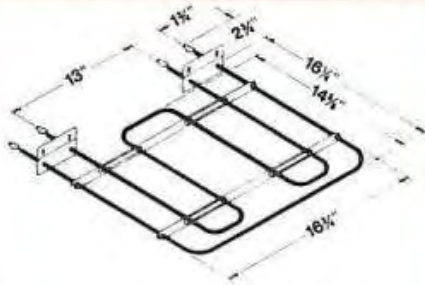
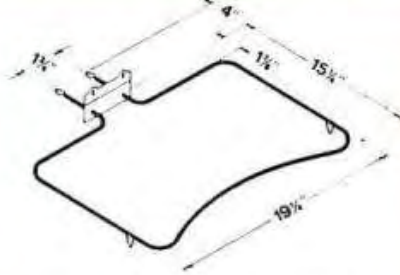
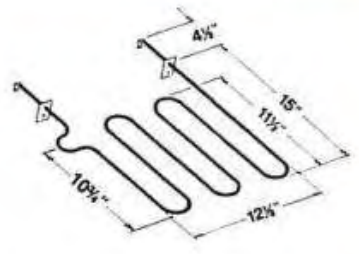
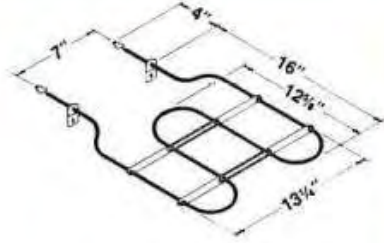
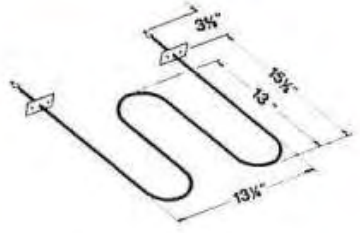
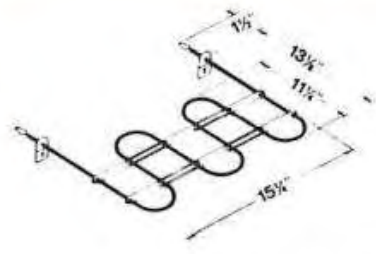
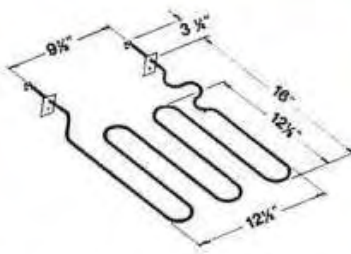
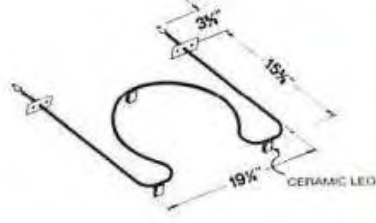
<p>CH4809 457692</p> <p>Sorry This Item Is No Longer Available</p> <p>Roper/Kenmore 235943 WATTS 2600 VOLTS 240</p>	<p>CH4822 457764</p>  <p>Roper/Kenmore 239082 WATTS 2500 VOLTS 240</p>	<p>CH4828 456411</p>  <p>Magic Chef 106-385M; 1938-323 WATTS 2800 VOLTS 240</p>
<p>CH4814 457730</p>  <p>Roper/Kenmore 237573 WATTS 2600/3600 VOLTS 208/240</p>	<p>CH4825 456770</p>  <p>Roper/Kenmore 309359; 324181 WATTS 2500 VOLTS 240</p>	<p>CH4829 456420</p>  <p>Magic Chef 106-585M; 1938-331 WATTS 2800 VOLTS 240</p>
	<p>CH4826 457860</p>  <p>Roper/Kenmore 309360; 316185; 324168 WATTS 3400 VOLTS 240</p>	<p>CH4830 456438</p>  <p>Roper 303615; 321884 WATTS 3200 VOLTS 240</p>
<p>CH4821 457561</p>  <p>Roper/Kenmore 238156 WATTS 3000 VOLTS 250</p>	<p>CH4827 456403</p>  <p>Magic Chef 106-975MR; 1938-320 WATTS 2750 VOLTS 240</p>	<p>CH4831 456446</p>  <p>Roper 303616; 319729; 319874; 321885 WATTS 2200 VOLTS 240</p>



Backer

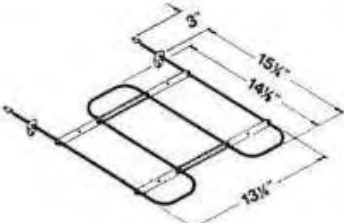
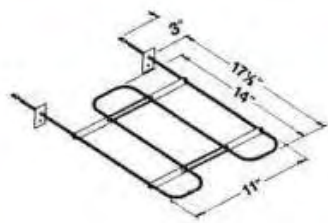
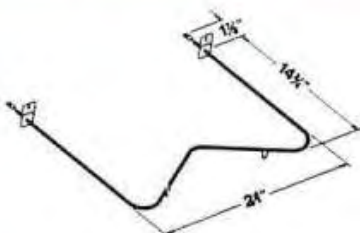
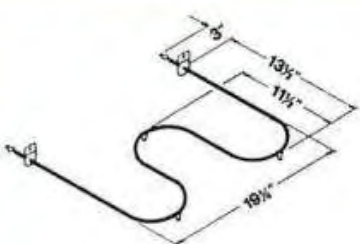
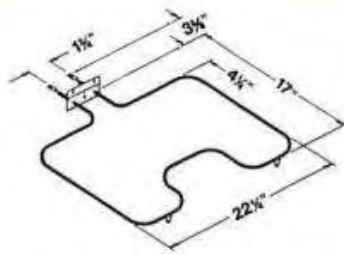
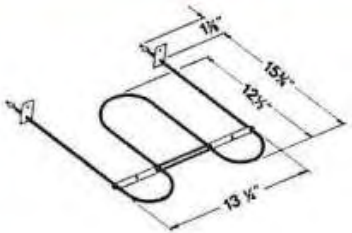
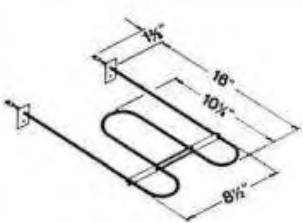
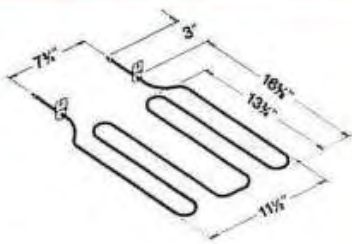
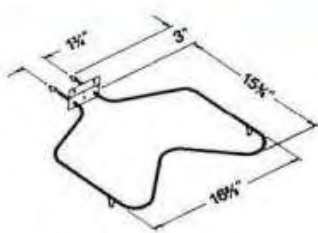
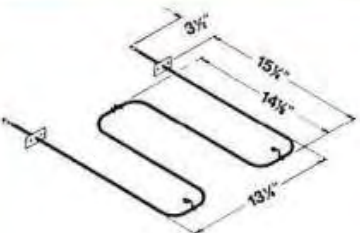
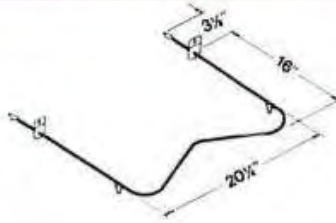

Bake & Broil Elements

<p>CH4832 456462</p>  <p>Sunray Stove 03002; 03002-04; 74098-01 WATTS 1900 VOLTS 250</p>	<p>CH4837 456518</p>  <p>Caloric 69061 Philco 3204-058-001 WATTS 3000 VOLTS 240</p>	<p>CH4841 456550</p>  <p>Boston Stove 43E4292 WATTS 2700 VOLTS 240</p>
<p>CH4833 456470</p>  <p>Sunray Stove 03001; 03001-04; 74096-00 WATTS 2600 VOLTS 250</p>	<p>CH4838 456526</p>  <p>Caloric 69060; 68142 WATTS 2500 VOLTS 240</p>	<p>CH4842 456569</p>  <p>Boston Stove 43E4293 WATTS 3000 VOLTS 240</p>
<p>CH4835 456497</p>  <p>Sunray Stove 03005-04; 74311-00 WATTS 3000 VOLTS 250</p>	<p>CH4839 456534</p>  <p>Caloric 75247 WATTS 2500 VOLTS 250</p>	<p>CH4843 456577</p>  <p>Distinctive Appliance K14242 Preway K14242 WATTS 3500 VOLTS 250</p>
<p>CH4836 456500</p>  <p>Whirlpool 308180; 311470; 313827; Jenn Air 201767; 202550 WATTS 2600/1950 VOLTS 240/208</p>	<p>CH4840 456542</p>  <p>Caloric 68038 WATTS 3000/2250 VOLTS 240/208</p>	<p>CH4844 456593</p>  <p>Distinctive Appliance 82100B Preway K16338 Kenmore 16338 WATTS 2200 VOLTS 240</p>



Backer

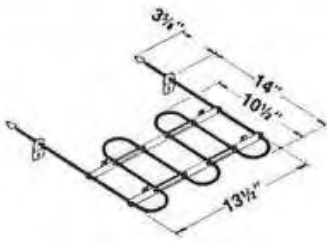
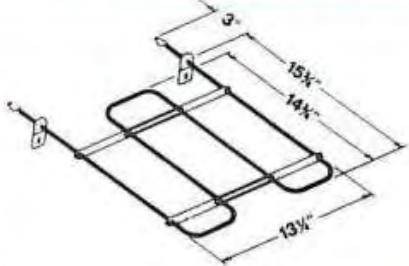
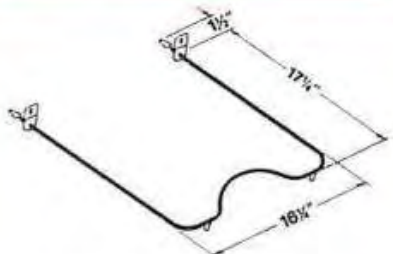
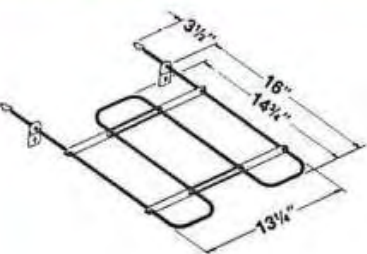
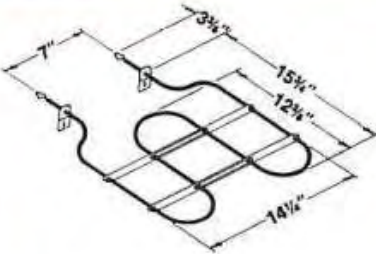
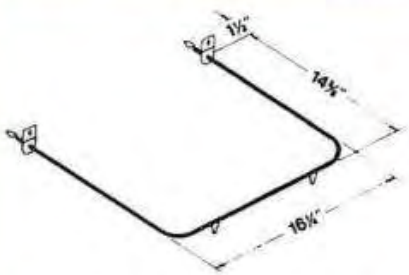
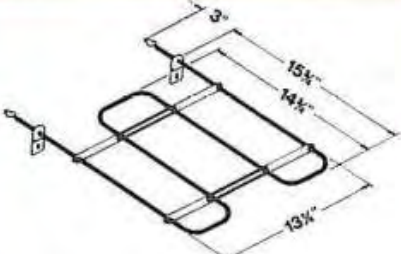
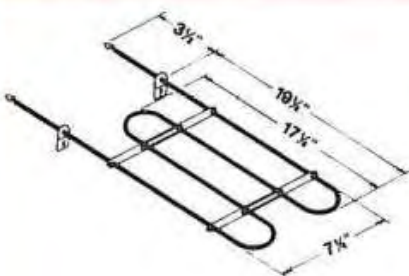

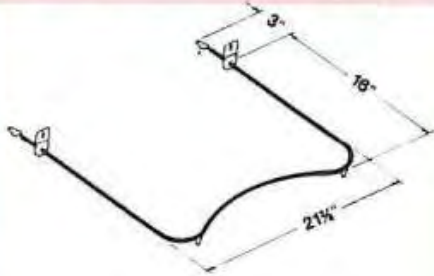
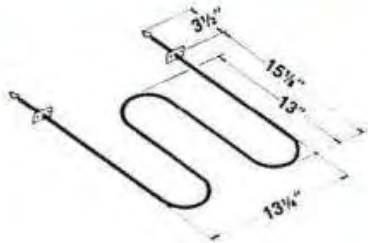
Bake & Broil Elements

<p>CH4845 457633</p>  <p>Roper/Kenmore 282718 WATTS 3600 VOLTS 240</p>	<p>CH4849 457676</p>  <p>Roper/Kenmore 293996 WATTS 3400 VOLTS 208</p>	<p>CH4854 457596</p>  <p>Roper 302449; 304977; 320415 WATTS 2000 Kenmore 302449; 327042 VOLTS 240</p>
<p>CH4846 457537</p>  <p>Roper/Kenmore 293105 WATTS 3400 VOLTS 240</p>	<p>CH4850 457684</p>  <p>Roper/Kenmore 296122; 319488; 324164; 324249; 324252 WATTS 3400 VOLTS 208</p>	<p>CH4855 457650</p>  <p>Roper/Kenmore 302451; 320414 WATTS 2000 VOLTS 240</p>
<p>CH4847 457545</p>  <p>Roper 293146; 299427; 299490 WATTS 3400 Kenmore 293146 VOLTS 240</p>	<p>CH4852 457721</p>  <p>Roper/Kenmore 299044 WATTS 3100 VOLTS 240</p>	<p>CH4856 457668</p>  <p>Roper 303801; 302342; 299043; 239120; 237572; 319843 WATTS 2300 Kenmore 303801; 299043; 237572; 319843 VOLTS 240</p>
<p>CH4848 457772</p>  <p>Roper/Kenmore 293995 WATTS 3400 VOLTS 208</p> <p>Sorry This Item Is No Longer Available</p>	<p>CH4853 457570</p>  <p>Roper/Kenmore 232184 WATTS 2500 277543; 302248; VOLTS 240</p>	<p>CH4858 456366</p>  <p>Roper/Kenmore 304666; 321890 WATTS 3200 VOLTS 208</p>

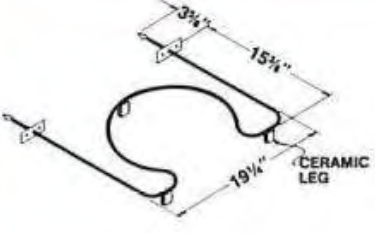
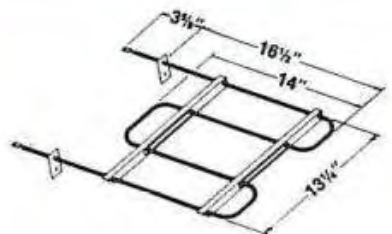
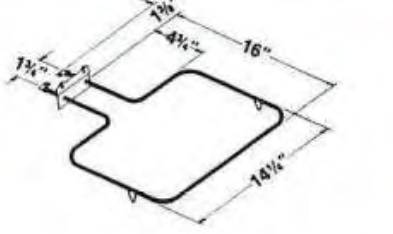
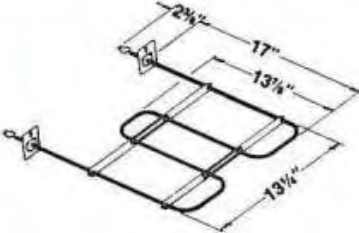
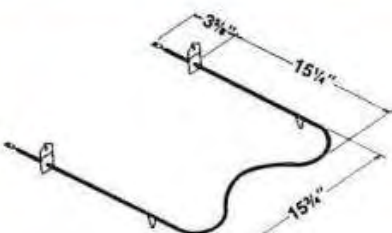
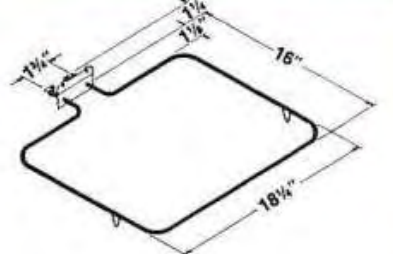
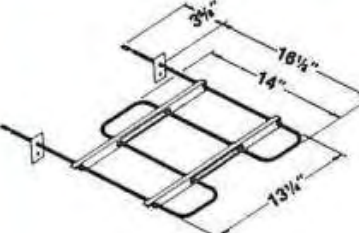
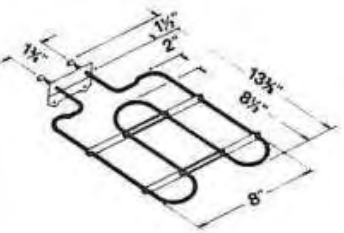
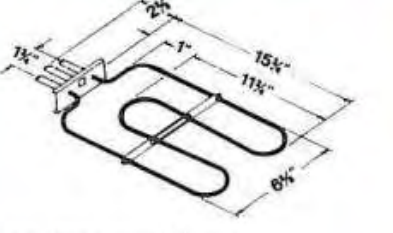
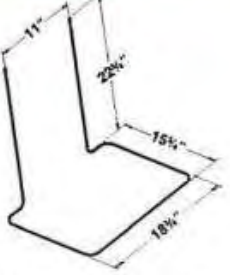
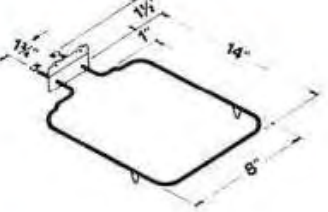

Backer

Bake & Broil Elements

<p>CH4859 456374</p>  <p>Roper/Kenmore 304667; 321891 WATTS 2200 VOLTS 208</p>	<p>CH4863 456382</p>  <p>Chambers/Kenmore 18078 WATTS 3000 VOLTS 208</p>	<p>CH4868 456817</p>  <p>Whirlpool/Kenmore 249613; 248216; 248509 WATTS 1900 VOLTS 240</p>
<p>CH4860 457588</p>  <p>Roper/Kenmore 630775 WATTS 3500 VOLTS 208</p>	<p>CH4864 456390</p>  <p>Chambers/Kenmore 18079 WATTS 2000 VOLTS 208</p>	<p>CH4869 456825</p>  <p>Whirlpool/Kenmore 250545; 265195 WATTS 3000 VOLTS 240</p>
<p>CH4861 457780</p>  <p>Chambers 11116; 17468; Q523-025 Kenmore 17468 WATTS 3000/2250 VOLTS 240/208</p>	<p>CH4866 457617</p>  <p>Roper/Kenmore 41996 WATTS 1800 VOLTS 240</p>	<p>CH4870 456753</p>  <p>Roper/Kenmore 31326; 31328 Kelvinator/Kenmore 1305816 WATTS 1500 VOLTS 240</p>
<p>CH4862 457799</p>  <p>Chambers 11117; 17507 Kenmore 17507 WATTS 750 VOLTS 120</p>	<p>CH4867 457756</p>  <p>Roper/Kenmore 41997 WATTS 1000 VOLTS 240</p>	<p>CH4871 457991</p>  <p>Sorry This Item Is No Longer Available</p> <p>Kelvinator/Kenmore 1306254 WATTS 1500 VOLTS 208</p>



Backer



Bake & Broil Elements

<p>CH4872 457887</p> <p>Kelvinator/Kenmore 1309020 WATTS 1500 VOLTS 208</p>	<p>CH4876 456729</p> <p>Kelvinator/Kenmore 1311494 WATTS 1500 VOLTS 208</p>	<p>CH4880 456745</p> <p>Kelvinator/Kenmore 1313170; 1313172 WATTS 2400 VOLTS 208</p>
<p>CH4873 457895</p> <p>Kelvinator/Kenmore 1310051 WATTS 3400 VOLTS 208</p>	<p>CH4877 457916</p> <p>Kelvinator/Kenmore 1311770 WATTS 3400 VOLTS 208</p>	<p>CH4881 456833</p> <p>Athens P-141-17 Kenmore 5375 WATTS 1500 VOLTS 240</p>
<p>CH4874 457908</p> <p>Kelvinator/Kenmore 1311292 Whirlpool 865934 WATTS 3400/2550 VOLTS 240/208</p>	<p>CH4878 457924</p> <p>Kelvinator/Kenmore 1312852; 1312854 Whirlpool 261913 WATTS 2400 VOLTS 208</p>	<p>CH4882 457932</p> <p>Athens P-141-14 Kenmore 5915; 6591 WATTS 3000 VOLTS 208</p>
<p>CH4875 456737</p> <p>Kelvinator 1308772 Kelvinator/Kenmore 1311493 Whirlpool 865971 WATTS 1500 VOLTS 240</p>	<p>CH4879 458003</p> <p>Frigidaire 8008245 Kelvinator/Kenmore 1313171; 1313169 Whirlpool 866375 WATTS 2400/1800 VOLTS 240/208</p>	<p>CH4883 457940</p> <p>Athens P-141-15 Kenmore 5916; 6592 WATTS 2000 VOLTS 208</p>



Backer

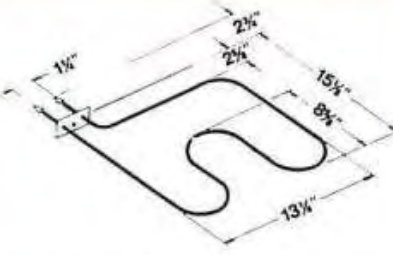
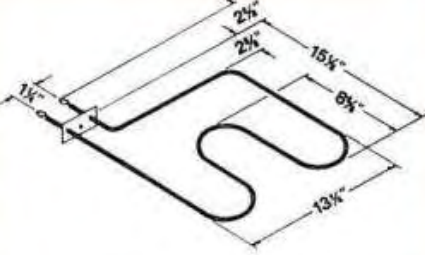
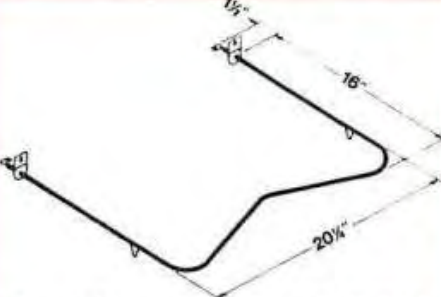
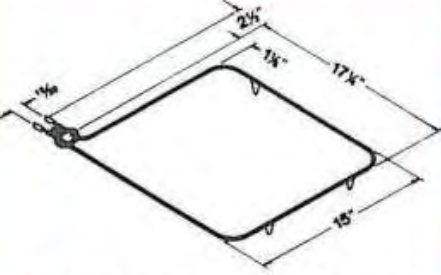
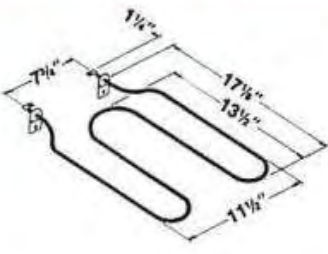
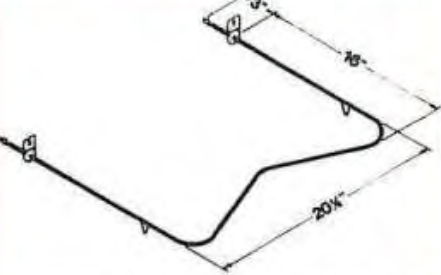
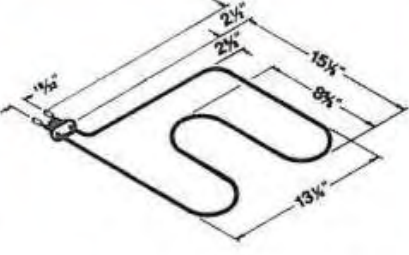
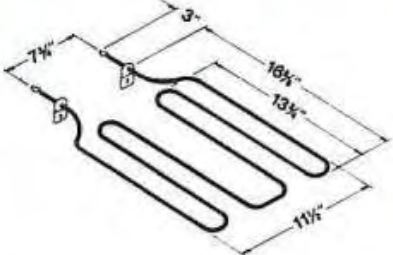
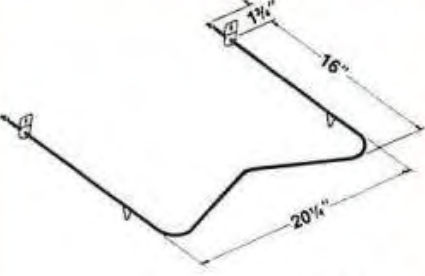

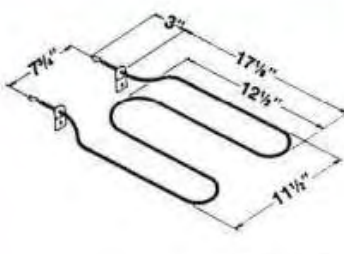
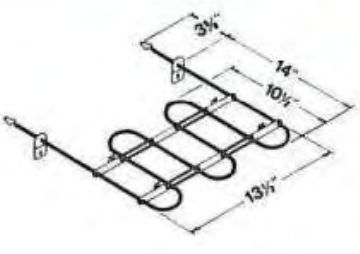
Bake & Broil Elements

<p>CH4884 456614</p>  <p>Athens E-141-030 Kenmore 7620</p> <p>WATTS 3000 VOLTS 250</p>	<p>CH4888 457983</p>  <p>Athens E-141-033 Kenmore 7621</p> <p>WATTS 3000 VOLTS 208</p>	<p>CH4892 457828</p>  <p>Preway/Kenmore K16337</p> <p>WATTS 2200 VOLTS 240</p>
<p>CH4885 457959</p>  <p>Athens E-141-024 Kenmore 6822</p> <p>WATTS 2000 VOLTS 208</p>	<p>CH4889 456841</p>  <p>Preway/Kenmore K12029</p> <p>WATTS 3000 VOLTS 208</p>	<p>CH4893 457836</p>  <p>Preway/Kenmore K16338; K14079</p> <p>WATTS 2600 VOLTS 240</p>
<p>CH4886 457967</p>  <p>Athens E-141-025 Kenmore 6823</p> <p>WATTS 3000 VOLTS 208</p>	<p>CH4890 457810</p>  <p>Preway/Kenmore K14078</p> <p>WATTS 3000 VOLTS 240</p>	<p>CH4894 457852</p>  <p>Preway/Kenmore K16388</p> <p>WATTS 2200 VOLTS 208</p>
<p>CH4887 457975</p>  <p>Athens E-141-022 Kenmore 7141</p> <p>WATTS 2400 VOLTS 208</p> <p>Sorry This Item Is No Longer Available</p>	<p>CH4891 456850</p>  <p>Preway/Kenmore K15910</p> <p>WATTS 3000 VOLTS 240</p>	<p>CH4895 457713</p>  <p>Roper/Kenmore 282853</p> <p>WATTS 3600 VOLTS 208</p>



Backer

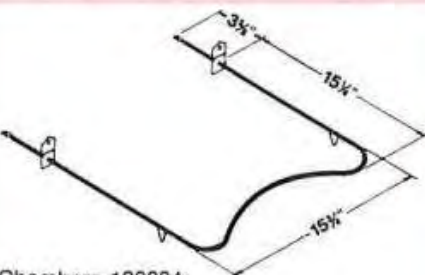
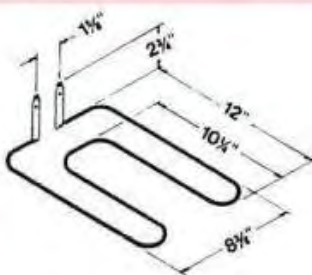
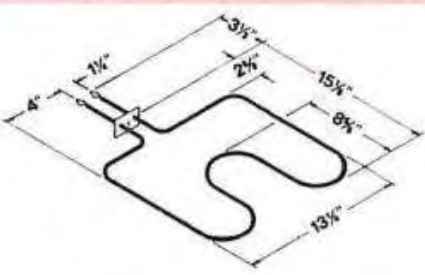
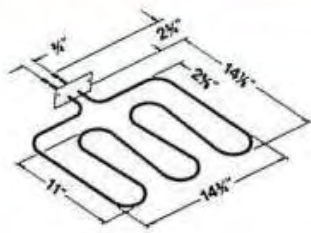
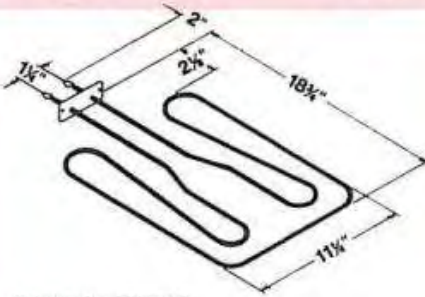
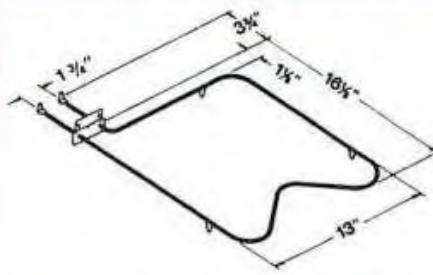
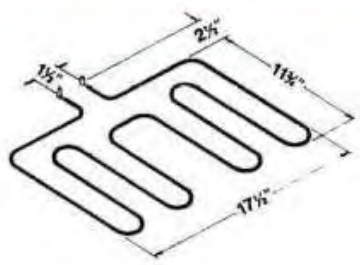
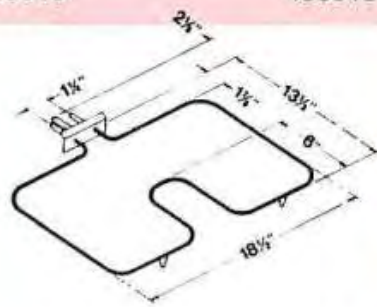
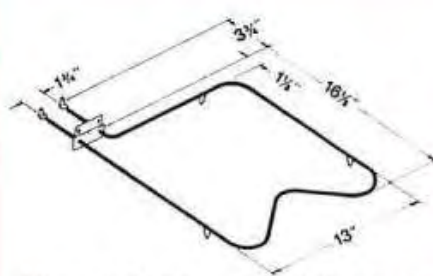
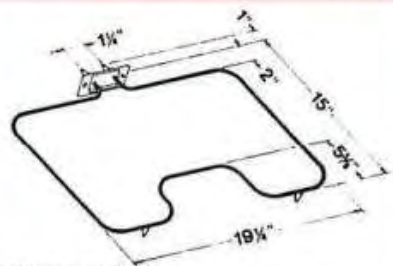
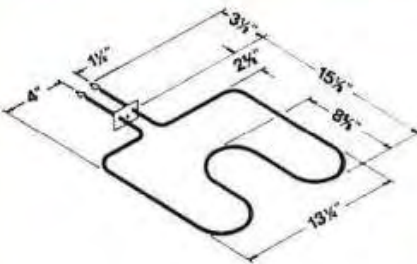

Bake & Broil Elements

<p>CH4896 457801</p>  <p>Chambers 126634; Q523026 Chambers/Kenmore 17692</p> <p>WATTS 2000/ VOLTS 240/208</p>	<p>CH5813 456892</p>  <p>Frigidaire 6564823</p> <p>WATTS 1750 VOLTS 240</p>	<p>CH5817 456930</p>  <p>Athens P-141-044 Kenmore 9504</p> <p>WATTS 3000 VOLTS 208</p>
<p>CH4897 456710</p>  <p>Westinghouse Q207621</p> <p>WATTS 3900/2930 VOLTS 240/208</p>	<p>CH5814 456905</p>  <p>Frigidaire 632248; 632321; 632236; 632238; 632277; 632417</p> <p>WATTS 3200 VOLTS 240</p>	<p>CH5818 456948</p>  <p>Athens P-141-037 Kenmore 9501</p> <p>WATTS 2000 VOLTS 250</p>
<p>CH5810 456868</p>  <p>Frigidaire 632335; 632342</p> <p>WATTS 3000/3255 VOLTS 240/250</p>	<p>CH5815 456913</p>  <p>Frigidaire 6564754; 7523311</p> <p>WATTS 2200 VOLTS 240</p>	<p>CH5819 456956</p>  <p>Athens P-141-041 Kenmore 9502</p> <p>WATTS 2000 VOLTS 208</p>
<p>CH5811 456876</p>  <p>Frigidaire 1133051; 632305; 632306; 7525769; 7525781; 7526602; 9950885</p> <p>WATTS 3350 VOLTS 250</p>	<p>CH5816 456921</p>  <p>Athens P-141-040 Kenmore 9503</p> <p>WATTS 3000 VOLTS 250</p>	<p>CH5820 456964</p>  <p>Frigidaire 1133474; 632071; 632073; 632309; 632310; 632311; 632312; 634706; 634707; 7525706; 7526607; 9950887</p> <p>WATTS 3000/2250 VOLTS 240/208</p>



Backer

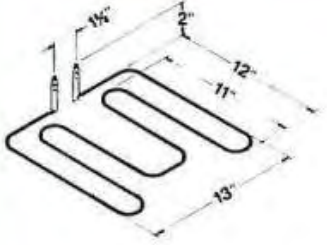
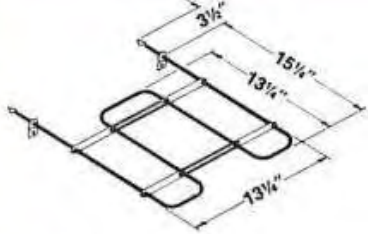
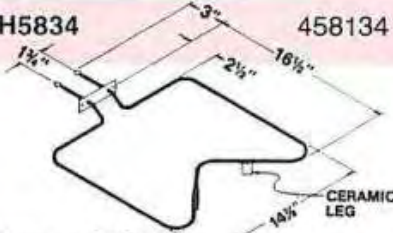

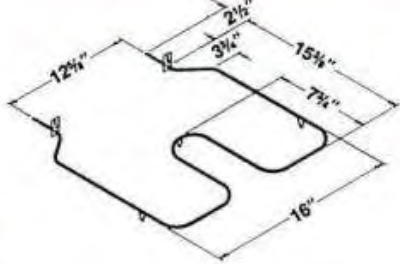
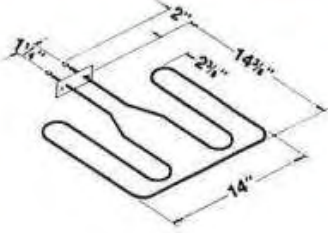
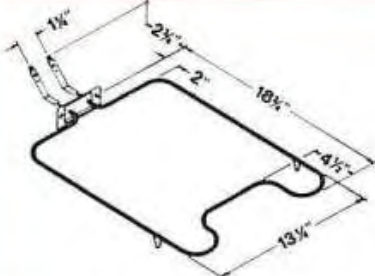
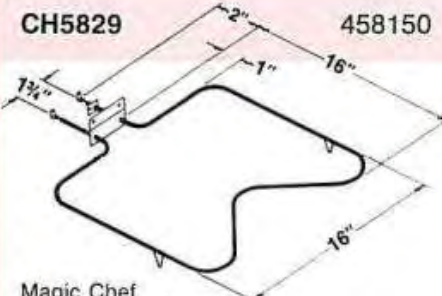
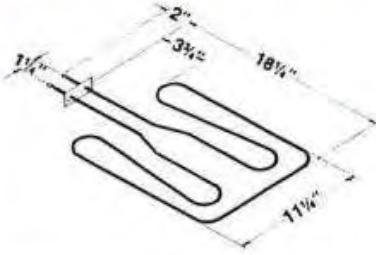
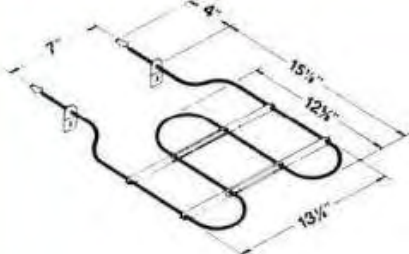
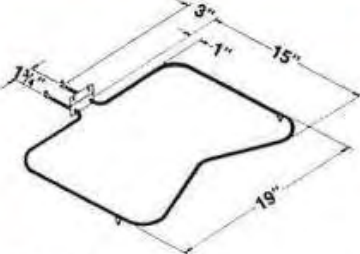
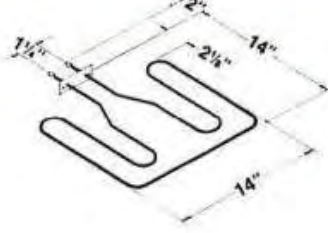
Bake & Broil Elements

<p>CH5821 456972</p>  <p>Frigidaire 630743</p> <p>WATTS 2400 VOLTS 240</p>	<p>CH5826 458038</p>  <p>Roper/Kenmore 319526; 319527; G.E. WB44X236</p> <p>WATTS 2550/3400 VOLTS 208/240</p>	<p>CH5834 458134</p>  <p>Chambers CC70855; CC70644A; CC70845; CC523-029E; Q523-029; CC70155; CC70662A; CC305337-4; CC305337-5</p> <p>WATTS 2200/1650 VOLTS 240/208 70845; 70855</p>
<p>CH5822 456980</p>  <p>Sorry This Item Is No Longer Available</p> <p>Frigidaire 515594; 7525585; 7525607</p> <p>WATTS 2200 VOLTS 208</p>	<p>CH5828 458142</p>  <p>Modern Maid 74-06-172 74-06-163</p> <p>WATTS 2500 VOLTS 240</p>	<p>CH5835 458214</p>  <p>Frigidaire 635621; 9951539</p> <p>WATTS 3370 VOLTS 250</p>
<p>CH5823 456999</p>  <p>Frigidaire 7534352; 630807</p> <p>WATTS 3000/2250 VOLTS 240/208</p>	<p>CH5829 458150</p>  <p>Magic Chef 106A-976M; 1938-325; 106A-96AM; 1938-362; 106A-964M; 1938-318; 106A-96DM</p> <p>WATTS 2750/2065 VOLTS 240/208</p>	<p>CH5836 458222</p>  <p>Frigidaire 635623; 9951540</p> <p>WATTS 3600 VOLTS 250</p>
<p>CH5824 458011</p>  <p>Roper/Kenmore 316186; 310353</p> <p>WATTS 3400 VOLTS 208</p>	<p>CH5830 458169</p>  <p>Magic Chef 106A-35AM; 1938-357</p> <p>WATTS 2585/1940 VOLTS 240/208</p>	<p>CH5837 458230</p>  <p>Frigidaire 635637</p> <p>WATTS 3370 VOLTS 250</p>

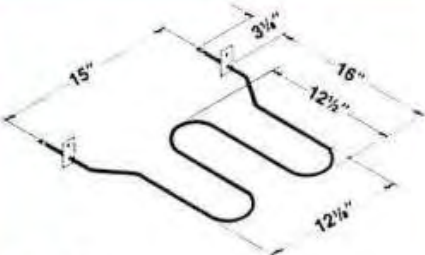
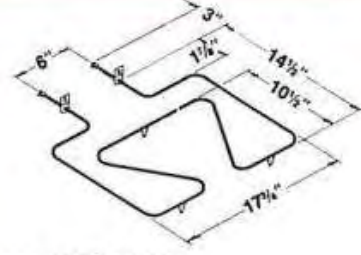

Backer

Bake & Broil Elements

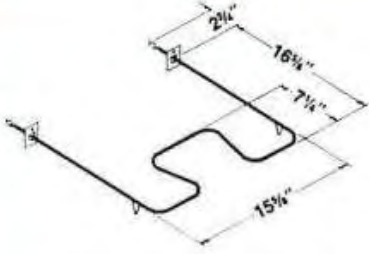
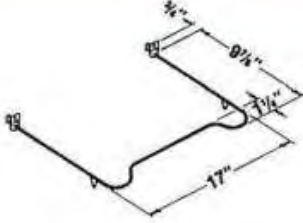
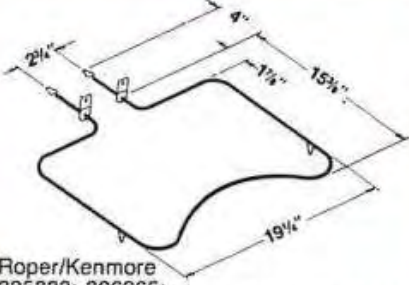
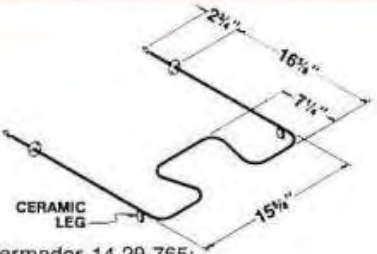
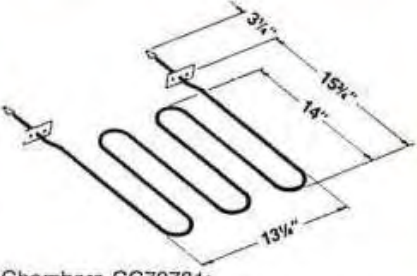
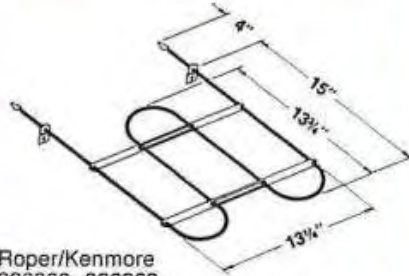
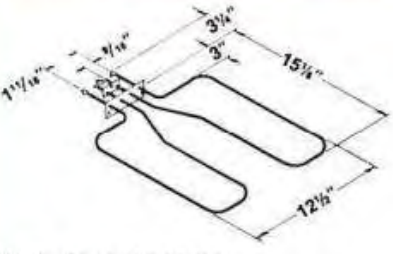
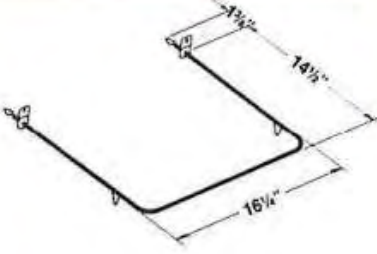
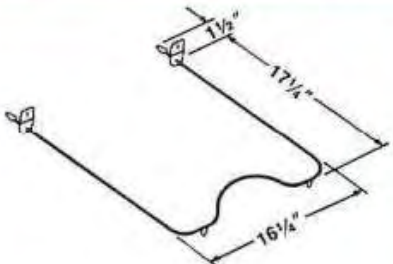
<p>CH5840 458265</p>  <p>Magic Chef 106-358M; 1938- 106-45AM</p> <p>WATTS 2700/2030 VOLTS 240/208</p>	<p>CH5847 458337</p>  <p>Tappan 221T011P06; 221T011P08; 221T011P11; 221T018P01</p> <p>WATTS 2400/1661 VOLTS 250/208</p>	<p>CH5851 458505</p>  <p>Roper/Kenmore 312438; 320419; 324207; 324713; 311734; 320418; 324206; 324712; 331164; 332563</p> <p>WATTS 1500/2000 VOLTS 208/240</p>
<p>CH5841 458273</p>  <p>Thermador 14-29-553; 14-29-554</p> <p>WATTS 2800 VOLTS 240</p>	<p>CH5848 458345</p>  <p>Tappan 221T019P01</p> <p>WATTS 1500/1038 VOLTS 250/208</p>	<p>CH5853 458521</p>  <p>Roper/Kenmore 325883; 326365; 326364; 326366; G.E. WB44X230</p> <p>WATTS 1875/2500 VOLTS 208/240</p>
<p>CH5842 458281</p>  <p>Thermador 14-29-765; 14-29-728; 14-29-555; 14-29-556; 14-29-726; 14-29-766; 14-39-311; 14-39-312</p> <p>WATTS 2800 VOLTS 240</p>	<p>CH5849 458358</p>  <p>Chambers CC70781; 305566-1; 305566-2 Kenmore CC70781</p> <p>WATTS 2800/2110 VOLTS 240/208</p>	<p>CH5855 458548</p>  <p>Roper/Kenmore 326360; 326362; 326361; 326363; 326938; 326939</p> <p>WATTS 2550/3400 VOLTS 208/240</p>
<p>CH5846 458329</p>  <p>Magic Chef 106-35CM; 106-35AM2; 106-35AM; 1938-358</p> <p>WATTS 3200/2400 VOLTS 240/208</p>	<p>CH5850 458361</p>  <p>Roper/Kenmore 303296; 320416; 324204</p> <p>WATTS 2000 VOLTS 208</p>	<p>CH5857 458070</p>  <p>Roper/Kenmore 327043; 303295; 320417; 324205</p> <p>WATTS 2000 VOLTS 208</p>



Backer

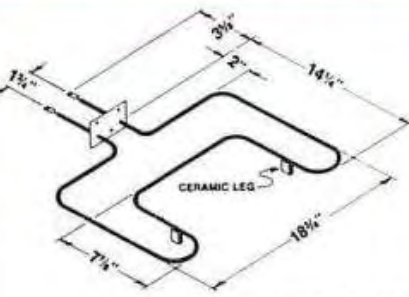
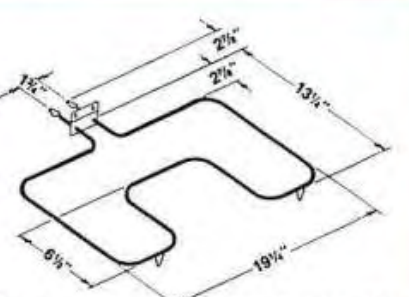
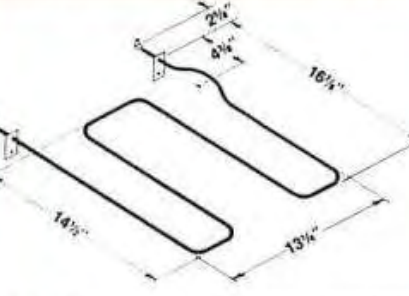
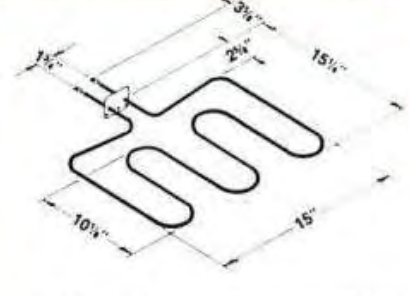
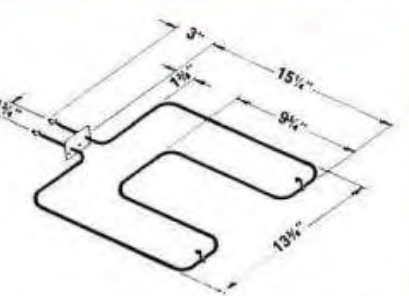
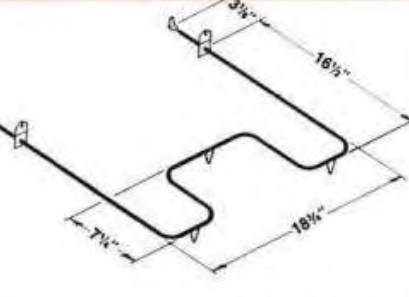
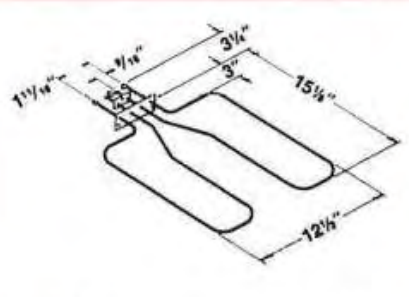
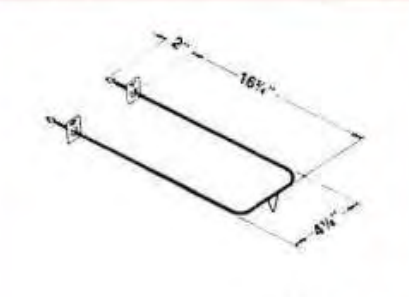
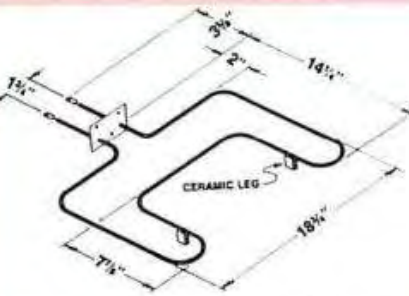
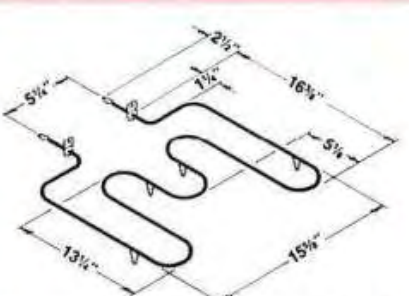
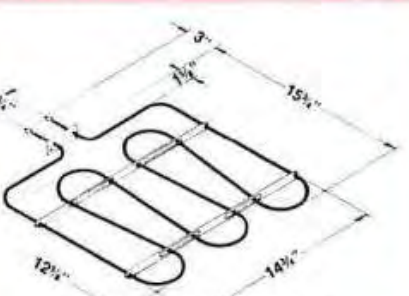

Bake & Broil Elements

<p>CH5860 458564</p>  <p>Amana C27341-1; C-27049-1</p> <p>WATTS 2500 VOLTS 240</p>	<p>CH5864 458601</p>  <p>Litton 41650P01</p> <p>WATTS 1920 VOLTS 240</p>	<p>CH5868 458644</p>  <p>Caloric 31-063531-04-0</p> <p>WATTS 2500/1878 VOLTS 240/208</p>
<p>CH5861 458572</p>  <p>Hardwick OE-002-171-99</p> <p>WATTS 2200/1650 VOLTS 240/208</p>	<p>CH5865 458610</p>  <p>Litton 52604P01; 52142P01</p> <p>WATTS 3500 VOLTS 240</p>	<p>CH5869 458652</p>  <p>Caloric 31-063532-04-0</p> <p>WATTS 3000/2250 VOLTS 240/208</p>
<p>CH5862 458580</p>  <p>Hardwick OE-001-050-99</p> <p>WATTS 2800/2100 VOLTS 240/208</p>	<p>CH5866 458628</p>  <p>Magic Chef 106-96CM</p> <p>WATTS 2750/2064 VOLTS 240/208</p>	<p>CH5870 458660</p>  <p>Caloric 91222</p> <p>WATTS 1500 VOLTS 240</p>
<p>CH5863 458599</p>  <p>Litton 52603P01; 53950P01; 52252P01</p> <p>WATTS 1920 VOLTS 120</p>	<p>CH5867 458636</p>  <p>Tappan 221T020P01</p> <p>WATTS 2400/1661 VOLTS 250/208</p>	<p>CH5871 458679</p>  <p>Amana 85289-1</p> <p>WATTS 3400 VOLTS 250</p>

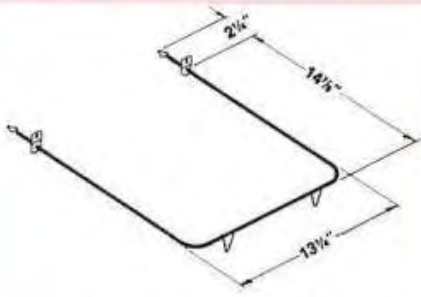
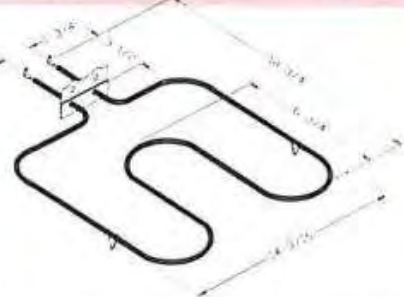
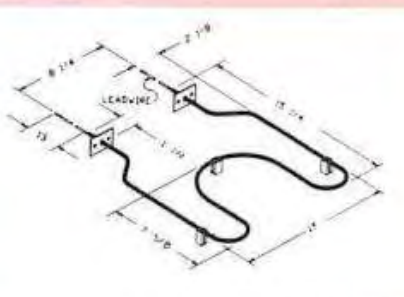
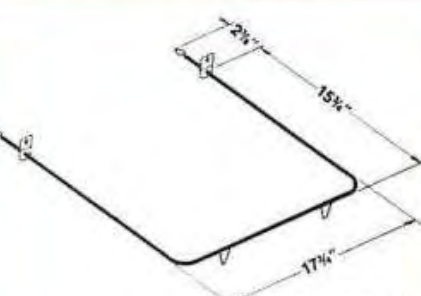

Backer

Bake & Broil Elements

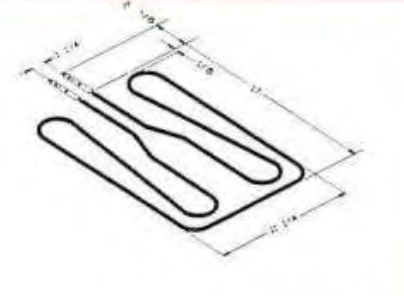
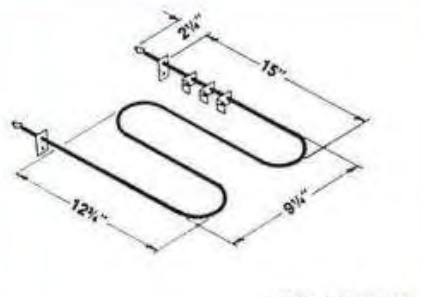
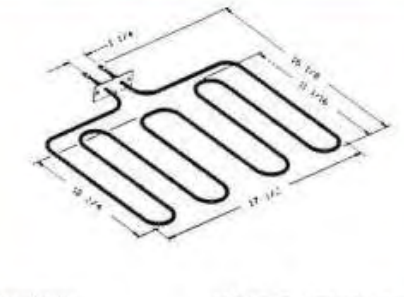
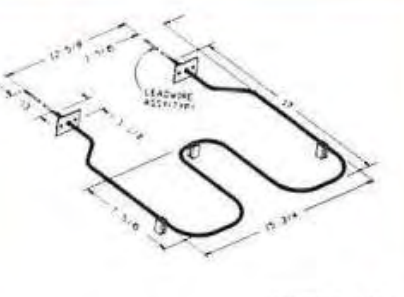
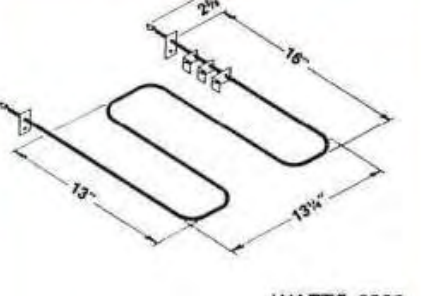
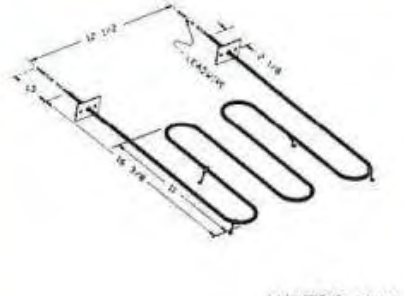
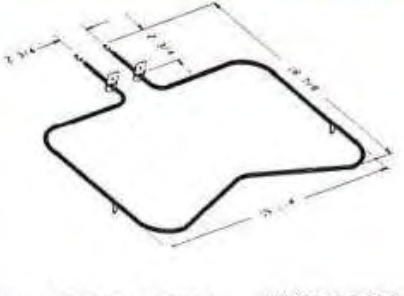
<p>CH5872 458687</p>  <p>Peerless Enamel P-138</p> <p>WATTS 1500 VOLTS 250</p>	<p>CH5887 440014</p>  <p>G.R. Mfg. 221G003P01</p> <p>WATTS 2100/1575 VOLTS 240/208</p>	<p>CH5891 440057</p>  <p>Caloric 31-051646-04-0</p> <p>WATTS 1000 VOLTS 240</p>
<p>CH5873 458695</p>  <p>Peerless Enamel P-143</p> <p>WATTS 2300 VOLTS 250</p>	<p>CH5888 440022</p>  <p>Jenn-Air 202551</p> <p>WATTS 3000/2250 VOLTS 240/208</p>	<p>CH5892 440065</p>  <p>Frigidaire 7522312</p> <p>WATTS 3600 VOLTS 240</p>
<p>CH5874 458708</p>  <p>Peerless Enamel P-139A</p> <p>WATTS 2800 VOLTS 250</p>	<p>CH5889 440030</p>  <p>Frigidaire N9951510</p> <p>WATTS 3600/3200 VOLTS 250/208</p>	<p>CH5893 440073</p>  <p>Caloric 31-051645-04-0</p> <p>WATTS 2500 VOLTS 240</p>
<p>CH5875 458716</p>  <p>Peerless Enamel P-144A</p> <p>WATTS 2800 VOLTS 250</p>	<p>CH5890 440049</p>  <p>Caloric 31-051644-04-0</p> <p>WATTS 2800 VOLTS 240</p>	<p>CH5894 440081</p>  <p>Roper 335912; 335913; G.E. WB44X237</p> <p>WATTS 2500 VOLTS 240</p>



Backer

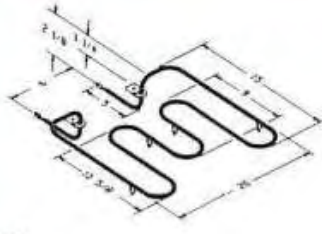
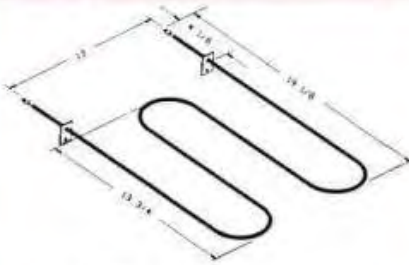
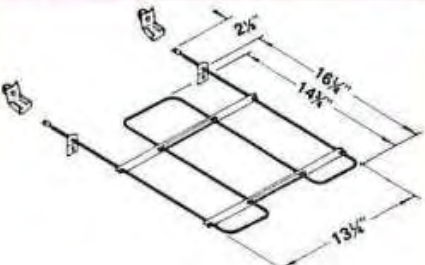
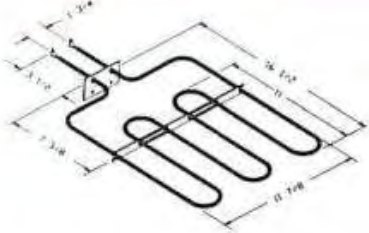
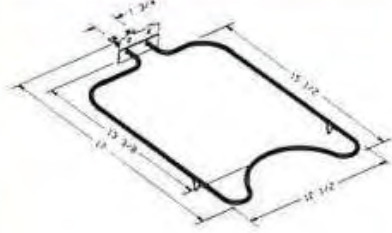
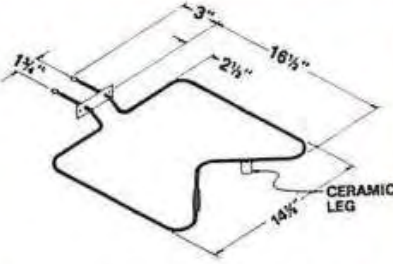
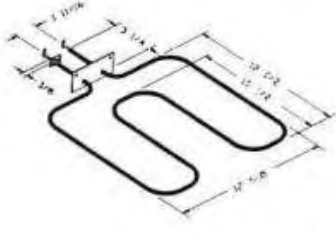
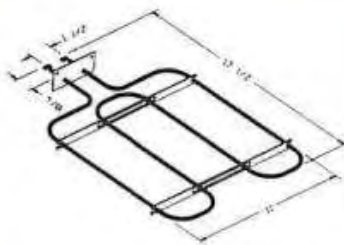
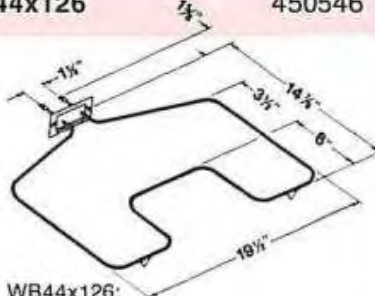
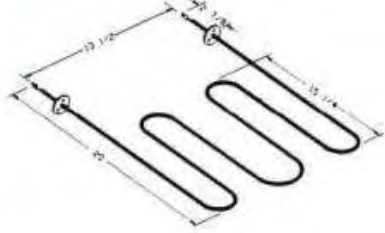
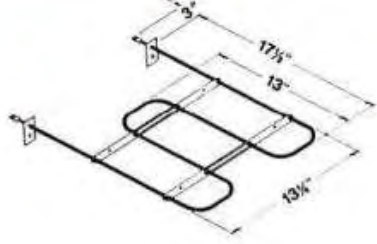
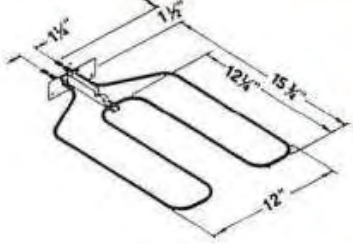

Bake & Broil Elements

<p>CH5895 440090</p>  <p>Tappan 221S001P01; 221T023P01; 221T023P03</p> <p>WATTS 2800/1938 VOLTS 250/208</p>	<p>CH5899 440137</p>  <p>Roper 334368; 334369; G.E. WB44X232</p> <p>WATTS 3400 VOLTS 240</p>	<p>CH6803 440170</p>  <p>Roper 113965; 113966; 237571</p> <p>WATTS 3600 VOLTS 240</p>
<p>CH5896 440102</p>  <p>G.R. Mfg. 220G004P01</p> <p>WATTS 3400/2550 VOLTS 240/208</p>	<p>CH6800 440145</p>  <p>Jenn Air 715269</p> <p>WATTS 2000/1500 VOLTS 240/208</p>	<p>CH6804 440188</p>  <p>CERAMIC LEG</p> <p>Chambers CC70907; CC305337-3; CC305337-2</p> <p>WATTS 2200 VOLTS 208</p>
<p>CH5897 440110</p>  <p>Magic Chef 7406P032-60</p> <p>WATTS 3200 VOLTS 240</p>	<p>CH6801 440153</p>  <p>Jenn Air 15416</p> <p>WATTS 2000 VOLTS 240</p>	<p>CH44x126 450546</p>  <p>G.E. WB44x126; WB44x118; WB44x105; WB44x120; WB44x112; WB44x133 Hotpoint 297B774G3</p> <p>WATTS 3000 VOLTS 250</p>
<p>CH5898 440129</p>  <p>Thermador Masco 14-39-313; 14-39-314</p> <p>WATTS 3600 VOLTS 240</p>	<p>CH6802 440161</p>  <p>Hardwick OE-002-170-99</p> <p>WATTS 2200/1650 VOLTS 240/208</p>	<p>CH44x134 454096</p>  <p>G.E. WB44x134</p> <p>WATTS 3000 VOLTS 250</p>



Backer

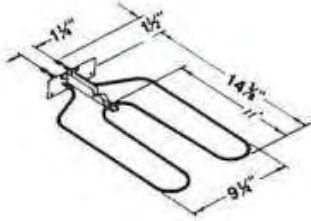
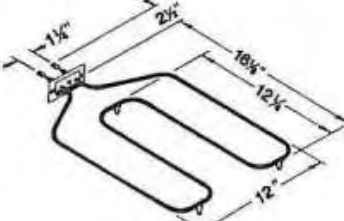
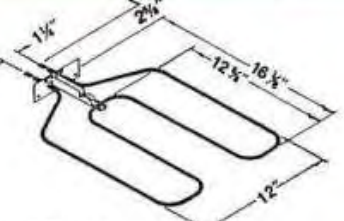
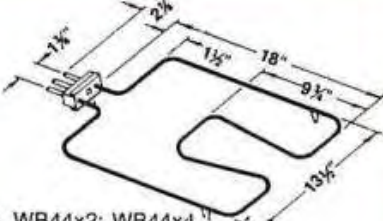
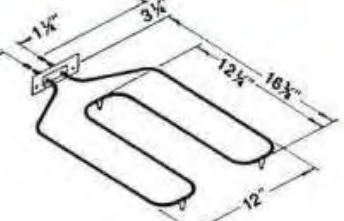

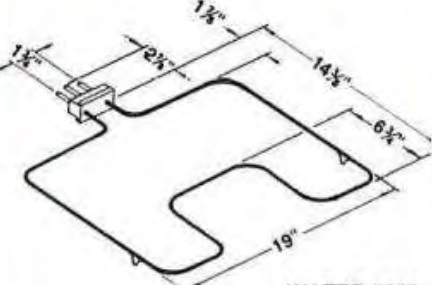
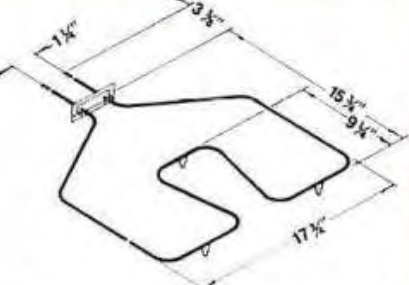
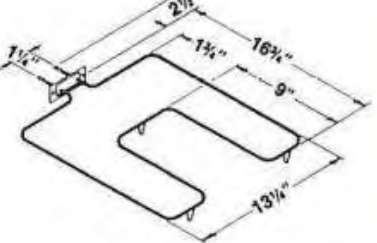
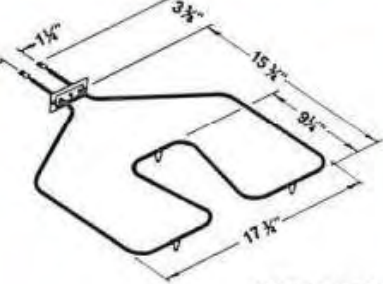
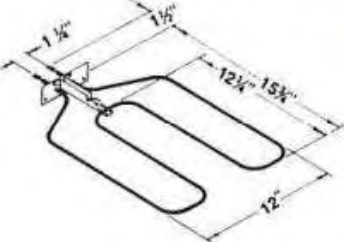
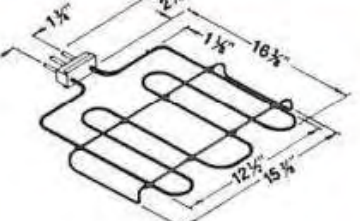
Bake & Broil Elements

<p>CH44x136 454512</p>  <p>G.E. WB44x136 WATTS 2585 VOLTS 250</p>	<p>CH44x165 454740</p>  <p>G.E. WB44x165 WATTS 3100 VOLTS 250</p>	<p>CH44x185 458302</p>  <p>General Electric WB44x149; WB44x150; WB44x167; WB44x168; WB44x173; WB44x185; WB44x5064 WATTS 3400 VOLTS 250</p>
<p>CH44x142 451629</p>  <p>G.E. WB44x2; WB44x4; WB44x6; WB44x67; WB44x94; WB44x142; WB45x3 Hotpoint 600136; 650040; WATTS 3000 660163; 660885; 661698 VOLTS 250</p>	<p>CH44x169 454766</p>  <p>G.E. WB44x169 WATTS 3100 VOLTS 250</p>	<p>CH44x196 458310</p>  <p>G.E. WB44x109; WB44x110; WB44x113; WB44x114; WB44x123; WB44x124; WB44x127; WB44x128; WB44x131; WB44x132; WB44x196 Hotpoint 663134 WATTS 2100 VOLTS 250</p>
<p>CH44x163 451637</p>  <p>G.E. WB44x163 WATTS 3000 VOLTS 250</p>	<p>CH44x170 454491</p>  <p>G.E. WB44x148; WB44x170 WATTS 3000 VOLTS 250</p>	<p>CH44x200 458290</p>  <p>G.E. WB44x200; WATTS 3100/2330 WB44x160 VOLTS 240/208</p>
<p>CH44x164 453173</p>  <p>G.E. WB44x164 WATTS 3000 VOLTS 250</p>	<p>CH44x180 454782</p>  <p>G.E. WB44x180; WB44x5063 WATTS 3410 VOLTS 250</p>	<p>CH44x5006 454774</p>  <p>Hotpoint 650324 G.E. WB44x5006 WATTS 3700 VOLTS 240</p>

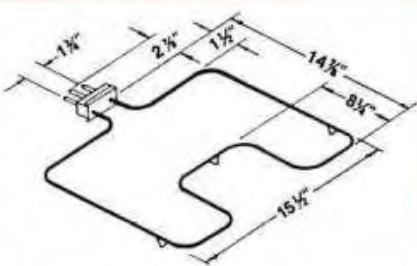
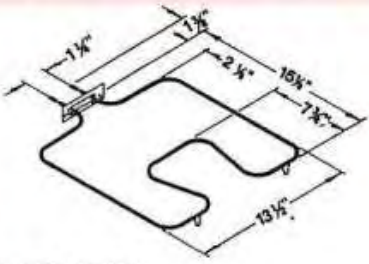
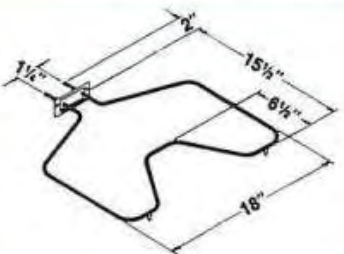
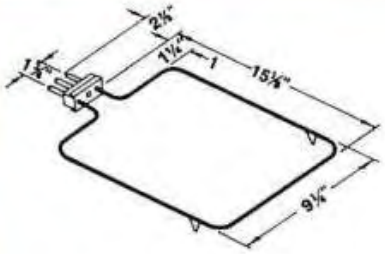
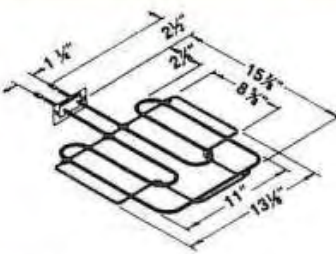
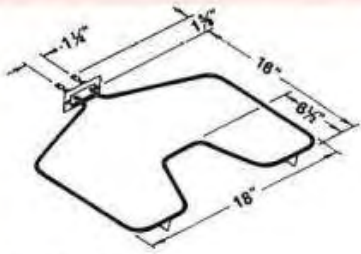
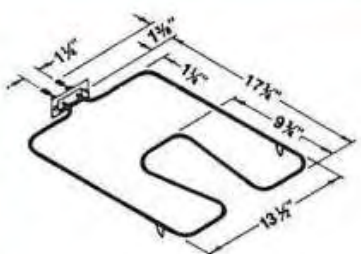
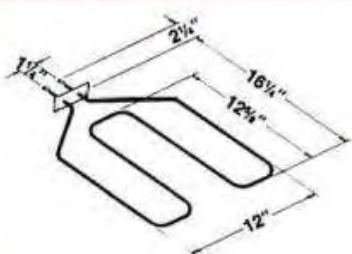
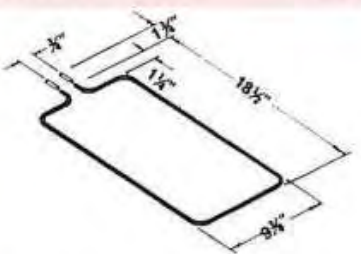
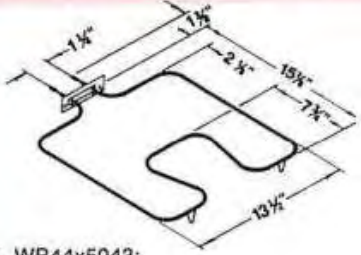

Backer

Bake & Broil Elements

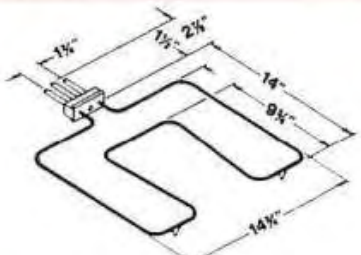
<p>CH44x5019 451119</p>  <p>G.E. WB44x5019 Hotpoint 661160; 661352; 661731</p> <p>WATTS 3000 VOLTS 250</p>	<p>CH44x5044 454900</p>  <p>G.E. WB44x5044; WB44x5050; WB44x5079; WB44x5081; WB44x5084</p> <p>WATTS 3000 Hotpoint 664641; 664730 VOLTS 208</p>	<p>CH44x5083 458206</p>  <p>G.E. WB44x5083; WB44x5085</p> <p>WATTS 2585 VOLTS 250</p>
<p>CH44x5021 454205</p>  <p>Hotpoint 661095; 662300 G.E. WB44x5021</p> <p>WATTS 1900 VOLTS 250</p>	<p>CH44x5045 453780</p>  <p>Hotpoint 663800; 664644; 663802 G.E. WB44x5045</p> <p>WATTS 3000 VOLTS 240</p>	<p>CH44x5099 454811</p>  <p>G.E. WB44x105; WB44x118; WB44x120; WB44x126; WB44x133; WB44x5061; WB44x5099</p> <p>WATTS 2585 VOLTS 250</p>
<p>CH44x5025 454846</p>  <p>G.E. WB44x5025; WB44x5 Hotpoint 663132</p> <p>WATTS 3000 VOLTS 250</p>	<p>CH44x5074 458185</p>  <p>G.E. WB44x5074</p> <p>WATTS 3410 VOLTS 250</p>	<p>CH45x30 452015</p>  <p>G.E. WB45x23; WB45x30; WB45x5021 Hotpoint 662385</p> <p>WATTS 2300 VOLTS 240</p>
<p>CH44x5043 454280</p>  <p>G.E. WB44x5043; WB44x5049; WB44x5078; WB44x5080 Hotpoint 663130; 664640; 664729</p> <p>WATTS 3000 VOLTS 250</p>	<p>CH44x5082 458193</p>  <p>G.E. WB44x5061; WB44x5082; WB44x5072</p> <p>WATTS 2585 VOLTS 250</p>	<p>CH45x50 451135</p>  <p>General Electric WB45x50</p> <p>WATTS 3000 VOLTS 250</p>



Backer

Bake & Broil Elements

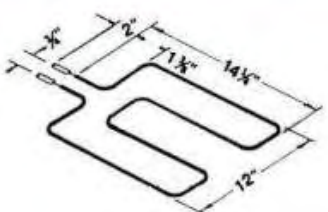
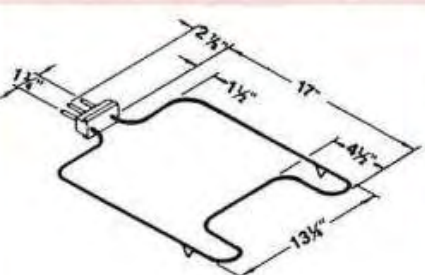
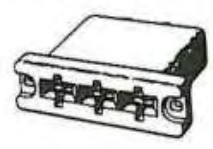
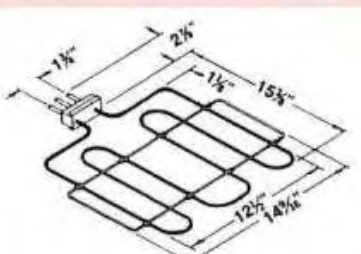
CH45x56		452007		Accessories	
		<p>G.E. WB44x108; WB44x116; WB45x56</p> <p>WATTS 3000 VOLTS 250</p>		<p>UC207 470061</p> <p>Sorry This Item Is No Longer Available</p> <p>Robertshaw 5445-275 Gemline GN207 Harpco 6700S0011</p>	
		<p>G.E. WB45x58; WB45x2; WB45x5008</p> <p>WATTS 3000 VOLTS 250</p>		<p>UC208 470070</p> <p>Sorry This Item Is No Longer Available</p> <p>GE WB45x5200 Gemline GN208 Robertshaw 5445-208</p>	
<p>CH45x5008 450562</p>		<p>ROR Oven Receptacle Block</p> <p>Fits 1" x 3" opening in back oven wall. Includes three OPC prong contacts with terminal screws. Can be used with all Universal Plug-in elements as well as many 3-prong plug-in elements.</p> 		<p>Catalog No. Product Code No.</p> <p>ROR 400565 OPC (contacts only) 400573</p>	
		<p>Hotpoint 662368; 661782 G.E. WB45x5020</p> <p>WATTS 3600 VOLTS 240</p>			



Backer

C

Water Heater Elements and Accessories

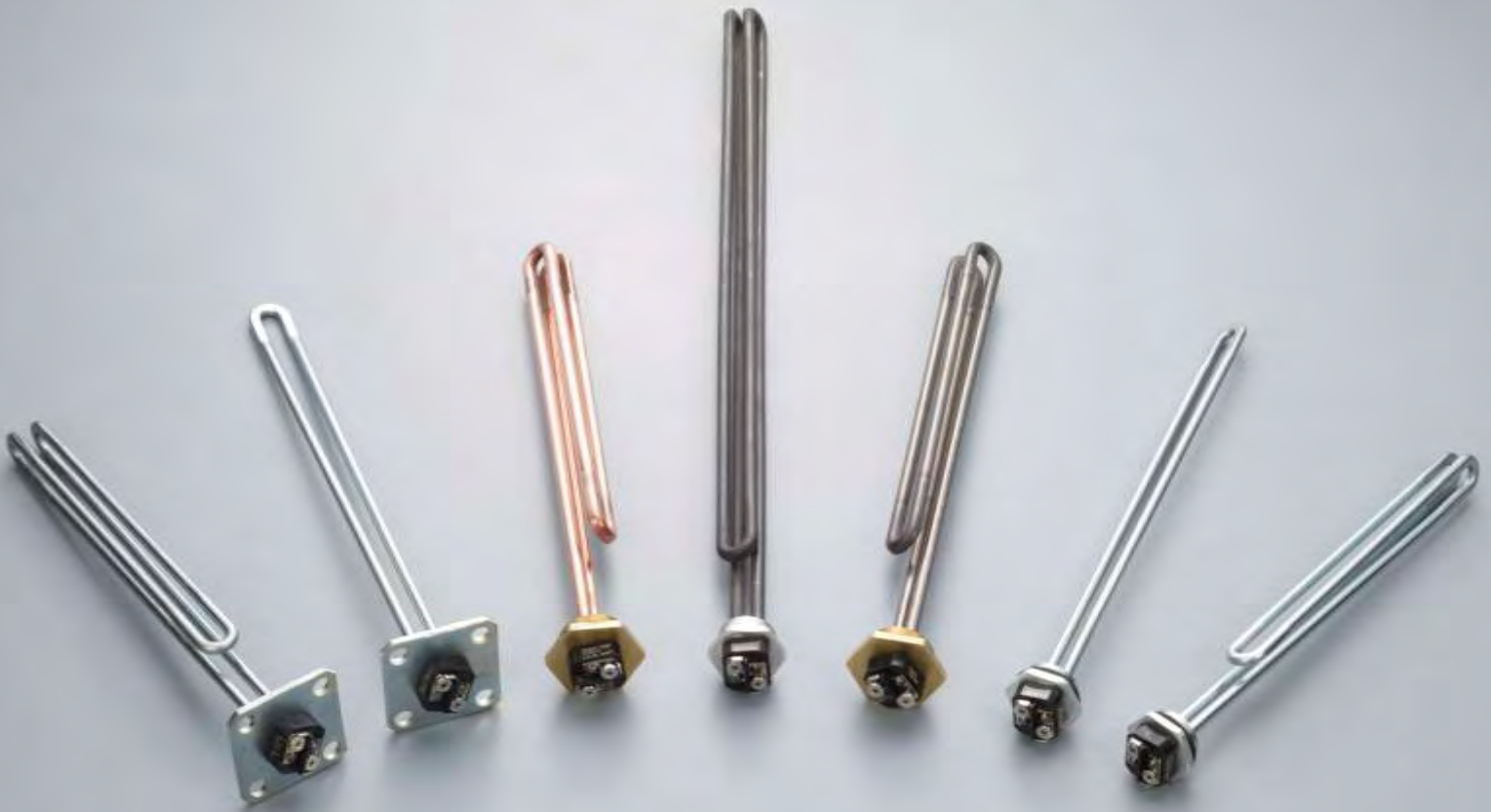

Backer EHP

4700 John Bragg Highway

Murfreesboro, TN 37127

(615) 907-6900

<http://www.backerehp.com>



Backer

Catalog # DA-707

Water Heater Elements

Screw-Plug Type

Type SG with gasket

Type SG elements are used as original equipment by all tank manufacturers. The elements are copper-sheathed, completely tinned to minimize galvanic action in glass-lined, galvanized or stone-lined tanks. Available in both high watt density and low watt density. Type AG-1 gasket is included.

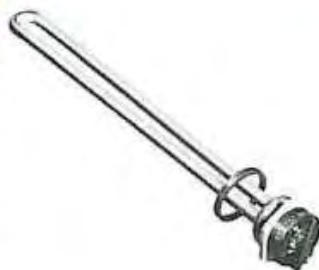

Volts	Watts	Catalog Number	Length Inside Tank	Product Code No.		
				Box	Skin Pack	Bulk
LOW WATT-DENSITY						
240	750	SG-1077	7 ³ / ₄	415206	416858	459567
240	1000	SG-1107	7 ³ / ₄	415214	416866	459161
240	1250	SG-1127	7 ³ / ₄	415222	418669	457385
240	1500	SG-1157	7 ³ / ₄	415230	418001	452613
240	2000	SG-1207	10 ¹ / ₁₆	415249	418010	452621
240	2500	SG-2257	7 ⁷ / ₁₆	415257	418028	452630
240	3000	SG-2307	9	415265	418677	452648
240	3500	SG-2357	9 ¹ / ₁₆	415273	418036	452656
240	4000	SG-2407	11 ³ / ₄	415281	418685	452664
240	4500	SG-2457	11 ³ / ₄	415290	418044	452672
240	5000	SG-2507	13 ⁷ / ₁₆	415302	416874	452681
240	5500	SG-2557	15 ¹ / ₁₆	415310	416882	459170
240	6000	SG-2607	15 ¹ / ₁₆	415329	416890	452760
120	750	SG-1077L	7 ³ / ₄	415337	416903	459575
120	1000	SG-1107L	7 ³ / ₄	415345	418052	457406
120	1250	SG-1127L	7 ³ / ₄	415353	416911	459129
120	1500	SG-1157L	7 ³ / ₄	415361	418781	459073
120	2000	SG-1207L	10 ¹ / ₁₆	417631	418706	455056

Volts	Watts	Catalog Number	Length Inside Tank	Product Code No.		
				Box	Skin Pack	Bulk
HIGH WATT-DENSITY						
240	1000	SG-1103	7 ⁵ / ₁₆	416014	416823	458100
240	1250	SG-1123	7 ⁵ / ₁₆	416022	417260	455363
240	1500	SG-1153	7 ⁵ / ₁₆	416030	417279	455355
240	2000	SG-1203	7 ⁵ / ₁₆	416057	417287	455339
240	2500	SG-1253	9 ³ / ₁₆	416073	417041	455320
240	3000	SG-1303	10 ⁹ / ₁₆	416081	417295	452867
240	3500	SG-1353	12 ⁹ / ₁₆	416090	417050	455312
240	4000	SG-1403	13 ⁹ / ₁₆	416102	417068	455380
240	4500	SG-1453	13 ⁹ / ₁₆	416110	417076	452859
240	4500	SG-2453	7 ¹ / ₁₆	417498	418650	459225
240	5000	SG-2503	9 ¹ / ₁₆	416129	417308	455398
240	5500	SG-2553	10 ¹ / ₁₆	414502	416831	457502
240	6000	SG-2603	11 ⁹ / ₁₆	416137	417316	455371
120	1000	SG-1103L	7 ⁵ / ₁₆	414510	416840	458118
120	1500	SG-1153L	7 ⁵ / ₁₆	416049	417324	455347
120	2000	SG-1203L	7 ⁵ / ₁₆	416065	417332	455400
120	2500	SG-1253L	9 ³ / ₁₆	417640	417340	457414

Flange Type

Type FTG with gasket

Type FTG Water Heater Elements are designed for use with recessed square tank flanges having four mounting holes on 2¹/₂" bolt circles. Available in both high watt-density and low watt-density. Type 045934-6 gasket is included and is also available separately.



Volts	Watts	Catalog Number	Length Inside Tank	Product Code No.		
				Box	Skin Pack	Bulk
LOW WATT-DENSITY						
240	750	FTG1077	7 ¹ / ₁₆	412283	418271	455451
240	1000	FTG1107	7 ¹ / ₁₆	412291	418280	455646
240	1250	FTG1127	7 ¹ / ₁₆	412654	418298	455822
240	1500	FTG1157	7 ¹ / ₁₆	412590	418300	455769
240	2000	FTG1207	10 ⁵ / ₁₆	412540	418319	455726
240	2500	FTG2257	7 ³ / ₈	412611	418327	455785
240	3000	FTG2307	8 ¹ / ₁₆	412961	418335	452875
240	3500	FTG2357	9 ⁷ / ₁₆	412523	418343	455700
240	4000	FTG2407	11 ¹ / ₁₆	412620	418351	455793
240	4500	FTG2457	11 ¹ / ₁₆	412515	418360	455830
240	5000	FTG2507	13 ³ / ₈	412574	416946	455742
240	5500	FTG2557	15 ¹ / ₁₆	414537	416954	458396
240	6000	FTG2607	15 ¹ / ₁₆	412558	416962	455734
120	1000	FTG1107L	7 ¹ / ₁₆	412460	418378	455460
120	1250	FTG1127L	7 ¹ / ₁₆	412646	418386	455814
120	1500	FTG1157L	7 ¹ / ₁₆	412582	418394	455750
120	2000	FTG1207L	10 ⁵ / ₁₆	412531	418407	455718

Volts	Watts	Catalog Number	Length Inside Tank	Product Code No.		
				Box	Skin Pack	Bulk
HIGH WATT-DENSITY						
240	1250	FTG1123	7 ⁵ / ₁₆	412304	418079	455478
240	1500	FTG1153	7 ⁵ / ₁₆	412312	418087	455486
240	1750	FTG1173	7 ⁵ / ₁₆	412320	418095	455494
240	2000	FTG1203	7 ⁵ / ₁₆	412339	418108	455507
240	2500	FTG1253	9 ³ / ₁₆	412347	418116	455515
240	3000	FTG1303	10 ⁹ / ₁₆	412355	418124	455523
240	3500	FTG1353	12 ⁹ / ₁₆	412363	418132	455531
240	4000	FTG1403	13 ⁹ / ₁₆	412371	418140	455540
240	4500	FTG1453	13 ⁹ / ₁₆	412380	418159	455558
240	2500	FTG2253	7 ⁵ / ₁₆	412390	418167	455566
240	3000	FTG2303	7 ⁵ / ₁₆	412400	418175	455574
240	3500	FTG2353	7 ⁵ / ₁₆	412419	418183	455582
240	4000	FTG2403	7 ¹ / ₁₆	412427	418191	455590
240	4500	FTG2453	7 ¹ / ₁₆	412435	418204	455603
240	5000	FTG2503	9 ¹ / ₁₆	412443	417842	455611
240	5500	FTG2553	10 ⁷ / ₁₆	414529	416920	458409
240	6000	FTG2603	11 ¹ / ₁₆	412451	416938	455620
120	1250	FTG1123L	7 ⁵ / ₁₆	412478	418220	455654
120	1500	FTG1153L	7 ⁵ / ₁₆	412486	418239	455662
120	2000	FTG1203L	7 ⁵ / ₁₆	412494	418247	455670
120	2500	FTG1253L	9 ³ / ₁₆	412507	418255	455697



Backer

Water Heater Elements

Flange Type

Type TG with gasket

These elements are identical to the original Chromalox elements now in use in hundreds of thousands of water heaters manufactured by RHEEM, A.O. SMITH, MOR-FLO, WAGNER, STATE STOVE, JACKSON, DUROMATIC, S.R.N., RUDD, AMERICAN-STANDARD. GTRF gasket included, however if tank has recessed tank flanges, use TG27T gasket.



Volts	Watts	Catalog Number	Length Inside Tank	Product Code No.		
				Box	Skin Pack	Bulk
LOW WATT-DENSITY						
240	750	TG1077	7 ¹¹ / ₁₆	411635	416786	459014
240	1000	TG1107	7 ¹¹ / ₁₆	411651	418423	452509
240	1250	TG1127	7 ¹¹ / ₁₆	411678	418431	457369
240	1500	TG1157	7 ¹¹ / ₁₆	411694	418440	452517
240	2000	TG1207	10 ⁵ / ₈	411715	418458	452525
240	2500	TG2257	7 ³ / ₈	411731	418474	452533
240	3000	TG2307	8 ¹⁵ / ₁₆	411740	418482	452541
240	3500	TG2357	9 ¹ / ₈	411758	418490	452550
240	4000	TG2407	11 ¹ / ₁₆	411766	418503	452568
240	4500	TG2457	11 ¹ / ₁₆	411774	418511	452576
240	5000	TG2507	13 ³ / ₈	411782	416794	452584
240	6000	TG2607	15 ¹ / ₁₆	413809	416807	459583
120	1000	TG1107L	7 ¹¹ / ₁₆	411643	416815	459241
120	1250	TG1127L	7 ¹¹ / ₁₆	411660	418520	452592
120	1500	TG1157L	7 ¹¹ / ₁₆	411686	418060	452605
120	2000	TG1207L	10 ⁵ / ₈	411707	418538	455048
120	2500	TG2257L	7 ³ / ₈	411723	418546	455030

"-BX" elements are "sickle shaped" to provide higher wattage at low watt density in confined tank areas.

**Sorry
This Item
Is No Longer
Available**

240	5500	TG2557BX	11 ¹ / ₁₆	412240	—	459591
240	6000	TG2607BX	15 ¹ / ₁₆	411790	—	459022

HIGH WATT-DENSITY

240	1000	TG-1103	7 ⁵ / ₈	416188	417156	411395
240	1250	TG-1123	7 ⁵ / ₈	416196	417164	411408
240	1500	TG-1153	7 ⁵ / ₈	416209	417172	411416
240	2000	TG-1203	7 ⁵ / ₈	416217	419936	411424
240	2500	TG-1253	9 ³ / ₈	416225	417009	411432
240	3000	TG-1303	10 ⁵ / ₈	416235	417188	411440
240	3500	TG-1353	12 ⁹ / ₁₆	416241	417017	455064
240	4000	TG-1403	13 ³ / ₁₆	416250	417025	411491
240	4500	TG-1453	13 ³ / ₁₆	416268	417033	411459
240	4500	TG-2453	7 ¹³ / ₁₆	417480	418415	459217
240	5000	TG-2503	9 ¹ / ₈	416276	417201	412195
240	6000	TG-2603	11 ¹ / ₁₆	416284	417210	411483
120	1000	TG-1103L	7 ⁵ / ₈	416170	417228	412208
120	1250	TG-1123L	7 ⁵ / ₈	416161	417236	457377
120	1500	TG-1153L	7 ⁵ / ₈	416153	417244	412216
120	2000	TG-1203L	7 ⁵ / ₈	416145	417252	455689
120	2500	TG-1253L	9 ¹ / ₈	417500	416778	459807

Round Flange Type

Type LS with gasket

Chromalox Type LS elements are exact replacements for original Chromalox elements used in water heaters having a recessed tank flange. (Used as original equipment by STATE STOVE and KENMORE). Elements are copper sheathed, heavily tin plated RLS kit included with boxed & skin packed elements.



Volts	Watts	Catalog Number	Length Inside Tank	Product Code No.		
				Box	Skin Pack	Bulk
LOW WATT-DENSITY						
240	1000	LS-1107	7 ¹¹ / ₁₆	414019	416989	459540
208	750					
240	1500	LS-1157	7 ¹¹ / ₁₆	414027	418554	452699
208	1125					
240	2000	LS-1207	10 ⁵ / ₈	414035	418562	452701
208	1500					
240	2500	LS-2257	7 ³ / ₈	414043	418570	452710
208	1875					
240	3000	LS-2307	8 ¹⁵ / ₁₆	414051	418589	452795
208	2250					
240	3500	LS-2357	9 ¹ / ₈	414060	418597	452728
208	2625					
240	4000	LS-2407	11 ¹ / ₁₆	414078	418600	452787
208	3000					
240	4500	LS-2457	11 ¹ / ₁₆	414086	418618	452736
208	3375					
240	5500	LS-2557	15 ¹ / ₁₆	414107	416760	452752
208	4125					
120	1000	LS-1107L	7 ¹¹ / ₁₆	414545	418626	452816
120	1500	LS-1157L	7 ¹¹ / ₁₆	414203	418634	452808
120	1650	LS-2167L	7 ³ / ₈	414174	418642	452744
120	2000	LS-1207L	10 ⁵ / ₈	414182	417834	459102

Volts	Watts	Catalog Number	Length Inside Tank	Product Code No.		
				Box	Skin Pack	Bulk
HIGH WATT-DENSITY						
240	1250	LS-1123	7 ¹¹ / ₁₆	417535	417359	455304
240	1500	LS-1153	7 ¹¹ / ₁₆	417541	417367	452824
240	2000	LS-1203	7 ¹¹ / ₁₆	417551	417375	455291
240	2500	LS-1253	9 ¹ / ₈	417560	417383	455435
240	3000	LS-1303	10 ⁵ / ₈	417578	417391	455427
240	3500	LS-1353	12 ⁹ / ₁₆	417586	417404	455419
240	4000	LS-1403	13 ³ / ₁₆	417594	417413	455283
240	4500	LS-1453	13 ³ / ₁₆	417519	417420	452832
240	6000	LS-2603	11 ¹ / ₁₆	414115	416970	459559
120	1500	LS-1153L	7 ¹¹ / ₁₆	417527	417439	452840
120	2000	LS-1203L	7 ¹¹ / ₁₆	416356	417447	457430
120	2500	LS-1253L	9 ¹ / ₈	—	—	458126



Backer

Water Heater Elements

Alloy Sheathed Elements

"Water Wizard" Alloy Sheathed Element

Type TGW with gasket
SGW with gasket

Copper sheathed water heater elements can be expected to fail in a short period of time when operating in free air (not covered with water) or when immersed in a heavy deposit of lime or sulphur. The latter condition is not unusual in many parts of the country.

The Chromalox "Water Wizard" is a possible solution to this problem, since the sheath material is a nickel base alloy similar to the Chromalox range surface elements. It will last longer than copper sheathed elements in free air and is less likely to overheat when immersed in mineral deposits.

Several water heater manufacturers now use these types of alloy sheathed elements as original equipment. Available replacements are the 2½" standard square flange (Type TGW) and the type SGW Screw plug elements which may also be used with Adapt-O-Matic Flanges (see page D-6) for special mounting applications.



Volts	Watts	Catalog Number	Length Inside Tank	Product Code No.	
				Box	Bulk
SQUARE FLANGE (Type TGW)					
240	1000	TGW1107	9 ³ / ₁₆ "	412689	457238
240	1250	TGW1127	10 ⁷ / ₈ "	412953	457246
240	1500	TGW2157	7 ⁹ / ₁₆ "	412937	457254
240	2000	TGW2207	8 ³ / ₃₂ "	413673	457043
240	2500	TGW2257	10 ¹ / ₁₆ "	412910	457035
240	3000	TGW2307	12 ¹ / ₃₂ "	412902	457051
240	3500	TGW2357	13 ³ / ₄ "	412890	457060
240	4000	TGW2407	15 ³ / ₄ "	412881	457078
240	4500	TGW2457X1	16 ¹ / ₄ "	413665	457094
240	5000	TGW2507	19 ¹ / ₈ "	412873	457086
120	1250	TGW1127L	10 ⁷ / ₈ "	412865	457107
120	1500	TGW2157L	7 ⁹ / ₁₆ "	412857	457115
120	2000	TGW2207L	8 ³ / ₃₂ "	412849	457123

Volts	Watts	Catalog Number	Length Inside Tank	Product Code No.	
				Box	Bulk
SCREW PLUG (Type SGW)					
240	1000	SGW1107	9 ⁵ / ₁₆ "	412830	457131
240	1250	SGW1127	11"	412822	457140
240	1500	SGW2157	7 ⁷ / ₁₆ "	412814	457158
240	2000	SGW2207	9 ³ / ₃₂ "	413657	457211
240	2500	SGW2257	10 ¹ / ₁₆ "	412806	457262
240	3000	SGW2307	12 ¹ / ₃₂ "	412785	457270
240	3500	SGW2357	13 ⁷ / ₈ "	412769	457289
240	4000	SGW2407	15 ⁷ / ₈ "	412742	457166
240	4500	SGW2457X1	16 ³ / ₈ "	412670	457220
240	5000	SGW2507	19 ¹ / ₄ "	412734	457174
120	1250	SGW1127L	11"	412726	457182
120	1500	SGW2157L	7 ⁷ / ₁₆ "	412718	457190
120	2000	SGW2207L	9 ³ / ₃₂ "	412700	457203



Backer

Water Heater Elements

Special Ratings and Styles

Type TG with gasket SG with gasket

These 208 and 480-volt elements are for replacement in many commercial applications including restaurants, institutions, hospitals, apartments and condominiums. Also widely used as original equipment in Booster Water Heaters by many manufacturers.



Special Voltage Units

Type TG — Flanged

Volts	Watts	Catalog Number	Length Inside Tank	Product Code No.
				Box
HIGH WATT-DENSITY				
208	2500	TG-1253	9 ³ / ₁₆	413278
208	3000	TG-1303	10 ⁷ / ₁₆	413286
208	4500	TG-1453	13 ³ / ₁₆	413315
208	5000	TG-2503	9 ¹³ / ₁₆	413323
480	4000	TG-1403	13 ³ / ₁₆	413411
480	4500	TG-1453	13 ³ / ₁₆	413420
480	5000	TG-2503	9 ¹³ / ₁₆	413438
480	6000	TG-2603	11 ³ / ₈	413446

Type SG — Screw-Plug

HIGH WATT-DENSITY				
Volts	Watts	Catalog Number	Length Inside Tank	Product Code No.
				Box
208	3000	SG-1303	10 ¹ / ₁₆	413500
208	3500	SG-1353	12 ¹ / ₁₆	413518
208	4500	SG-1453	13 ¹ / ₁₆	413534
208	5000	SG-2503	9 ¹⁵ / ₁₆	413542
208	6000	SG-2603	11 ¹ / ₁₆	417623
480	2000	SG-1203	7 ³ / ₄	413577
480	2500	SG-1253	9 ¹ / ₂	413585
480	3000	SG-1303	10 ¹ / ₁₆	413593
480	3500	SG-1353	12 ¹ / ₁₆	413606
480	4000	SG-1403	13 ¹ / ₁₆	413614
480	4500	SG-1453	13 ¹ / ₁₆	413622
480	5000	SG-2503	9 ¹⁵ / ₁₆	413630
480	6000	SG-2603	11 ³ / ₄	413649

Type CH

This popular non-immersion type water heater element is an exact replacement for the hundreds of thousands now in use. Designed primarily for Mobile Homes, it heats the air within a chamber of the water tank which in turn heats the tank wall and then the water. Since no gaskets nor draining of the tank is involved, the replacement can be made in minutes.

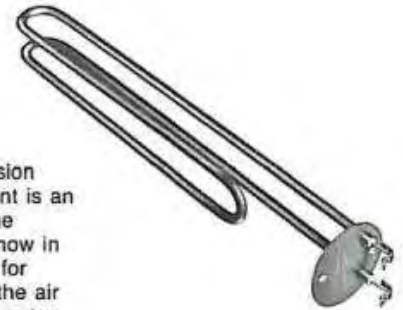

Volts	Watts	Catalog Number	Length Inside Tank	Product Code No.
				Box
120	1500	CH115	13 ³ / ₄	453991
240	1500	CH215	13 ³ / ₄	453982
240	2000	CH202	13 ³ / ₄	458054

Type OCH

Open Coil—non-immersion water heater elements for the mobile home market.



Volts	Watts	Catalog Number	Length Inside Tank	Product Code No.
				Box
120	1500	OCH115	12	422027
240	2000	OCH220	12	422060
240	3000	OCH230	12	422078



Backer

Water Heater Elements

Adapt-O-Flanges

Type ADF

Heating element replacement is possible by using the proper combination of any "SG" style elements and one of the five (5) Adapt-O-Flanges listed below.



ADF-1



ADF-2



ADF-3

Sorry
This Item
Is No Longer
Available
ADF-4

Sorry
This Item
Is No Longer
Available
ADF-5

Description	Included Gaskets	Catalog Number	Product Code Number
Square—2½" bolt circle 1⅞" centers	GTRF (General Purpose) FG-1B (Twist Lock)	ADF-1	415011
Square—2¾" bolt circle 1⅝" centers	FG-24	ADF-2	415020
Square—3¼" bolt circle 2⅝" centers	FG-35	ADF-3	415038

Adapt-O-Matic Gaskets

Although the appropriate Adapt-O-Matic gasket comes with both the Adapt-O-Matic element and the Adapt-O-Flanges, they are also available separately.

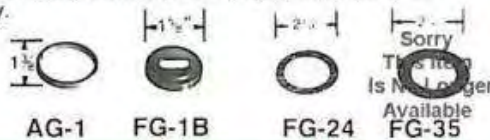

Description	Catalog No.	Product Code No.
Gasket for Adapt-O-Matic element	AG-1	415708
Twist-lock Gasket for ADF-1	FG-1B	415724
Gasket for ADF-2 and ADF-4	FG-24	415732

FTG Gasket

Use with FTG element in recessed Tank Flange

FTG Gasket
(045934-6)



Catalog Number	Product Code No.
045934-6	412662

Accessories



Description	Catalog No.	Product Code No.
Standard Gasket	TG27-T	412187
Use with TG & TSFS when tank has recessed tank flange.		
Rubber Gasket	TG8-TA	411820
Use with all types when tank flange is twist lock type.		
Thermostat Bracket (Half)	TG12	411168
Use with Type TG, TGFR & TSFS.		
Bolt (¼-28 UNF straight thread, hex head with built-in washer)	TG-19R	412224
Use if original bolts are stripped or too short.		
Gasket	GTRF	411088
Use with TG and TSFS when tank has flat, 2½" square tank flange.		

RLS Mounting Kit

Mounting kit contains one (1) RLS-17B gasket, one (1) RLS-12TH bracket and four (4) RLS-19TH self-tapping screws.



Description	Catalog Number	Product Code Number
Thermostat Bracket	RLS-12TH	414262
Mounting Kit	RLS-Kit	414289



Backer

Water Heater Elements

Water Heater Controls

High Limit Controls

Type HLC high-limit controls are for use with Chromalox R5025C & R5135C thermostats. U.L. requires a device like HLC on all electric water heaters.



HLC

Sorry This Item Is No Longer Available

Description	Rating	Catalog No.	Product Code No.
Will automatically cutoff when water temperature reaches 199 ± 5°	10 amps @ 120-240 V.A.C. 20 amps @ 240/288 V.A.C.	HLC	411598

Thermostats

Type R adjustable thermostats are designed for replacement on all storage-type electric water heaters and may be used with immersion and wrap-around elements.



R5025C



R5135C

Sorry This Item Is No Longer Available

Description	Rating	Catalog No.	Product Code No.
Available in single or double throw. Both have temperature range of 120° to 170°F	6000W @ 208, 240, 480 V.A.C. (D.O.D.)	R5025C	411133 (single-throw)
	2100W @ 240 V.A.C.	R5135C	411141 (double-throw)

Combination Unit

Type AW is a special all-inclusive unit consisting of a type HLC control and R5025C (single-throw) or R5135C (double-throw) thermostat.



AW7025HLC



AW7135HLC

Sorry This Item Is No Longer Available

Description	Catalog No.	Product Code No.
Includes HLC control and either R5025C (single-throw) or R5135C (double-throw) thermostat.	AW-7025/HLC (single-throw)	413753
	AW-7135/HLC (double-throw)	413770

Socket Wrench

For Screw Plug Elements

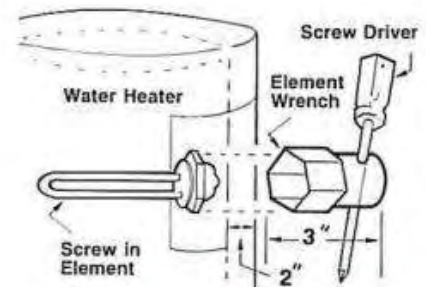

Description	Product Code No.
SW1 Socket Wrench	472008



Backer

Water Heater Elements

Water Heater Controls New Styles

High Limit Controls



66T4400
(High Limit Control)

Description	Rating	Catalog No.	Product Code No.
Will automatically cutoff when water temperature reaches 190°F ±5°.	40 amps @ 120-240 V.A.C. 25 amps @ 241-480 V.A.C.	66T4400	413868

Thermostats



59T4000



59T4100

Description	Rating	Catalog No.	Product Code No.
Available in single or double throw. Both have temperature range of 120°F to 170°F.	6000W @ 208, 240, 480 V.A.C. 3000W @ 120 V.A.C.	59T4000	413876
		(single-throw)	
		59T4100	413850
		(double-throw)	

Combination Units



Combo 59T/66T3M2



59T/66T3M

Description	Catalog No.	Product Code No.
Includes high limit control and either 59T4000 (single throw) or 59T4100 (double throw) thermostat.	59T/66T3M2 (single-throw)	413841
	59T/66T3M (double-throw)	413884



Backer

D

Special Purpose Elements



Backer EHP

4700 John Bragg Highway

Murfreesboro, TN 37127

(615) 907-6900

<http://www.backerehp.com>



Backer

Catalog # DA-707

Special Purpose Elements

Refrigerator Defroster Elements

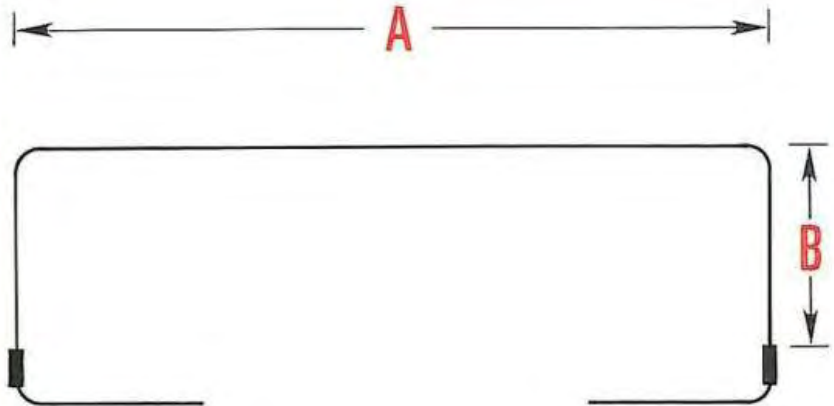

Dimensions — inches		Specifications		OEM Number	Catalog No.	Product Code No.
A	B	Volts	Watts			
23 ⁵ / ₈	4 ¹ / ₂	120	650	Whirlpool 978331	CH413	458724
26 ⁵ / ₈	4 ¹ / ₂	120	650	Whirlpool 978332	CH414	458732



Backer

Special Purpose Elements

<p>Ceiling heating elements</p>	<p>CH141 456657</p>  <p>Nutone C-18041; C-23254; C-21356 WATTS 1200 VOLTS 120</p>	<p>CH152 456681</p> <p>Sorry This Item Is No Longer Available</p>  <p>Markel A-699; A-698 WATTS 1000 VOLTS 120</p>
<p>CH136 453940</p>  <p>Nutone C-15928 WATTS 1000 VOLTS 120</p>	<p>CH143 456665</p>  <p>Nutone C-26718; C-23253 WATTS 1150 VOLTS 240</p>	<p>CH154 456690</p>  <p>Nutone WATTS 1000 VOLTS 120</p>
<p>CH137 456630</p>  <p>Broan 99-27-0039 WATTS 1240 VOLTS 120</p>	<p>CH148 453974</p>  <p>Emerson-Pryne 1802015 WATTS 1000 VOLTS 120</p>	<p>CH155 456702</p> <p>Sorry This Item Is No Longer Available</p>  <p>Fasco 657-21 WATTS 1000 VOLTS 120</p>
<p>CH138 456649</p> <p>Sorry This Item Is No Longer Available</p>  <p>Markel A-781; A-783 WATTS 1000 VOLTS 120</p>	<p>CH149 456673</p>  <p>Nutone C-10593; C-16476 WATTS 1475 VOLTS 120</p>	<p>RESERVED FOR ADDITION TO THE CEILING HEATER LINE</p>



Backer

Special Purpose Elements

<p>Grill Elements</p>	<p>CH4820 457641</p> <p>Sorry This Item Is No Longer Available</p>  <p>WATTS 1500 Roper/Kenmore 291213 VOLTS 208</p>	<p>CH6808 440225</p>  <p>Whirlpool, Kitchen Aid Chambers 307672-1 WATTS 1700 VOLTS 120</p>
<p>CH4817 456450</p>  <p>Roper 310604 WATTS 1500 VOLTS 240</p>	<p>CH6805 440196</p>  <p>Thermador 14-39-160; 14-39-161; 14-39-162 WATTS 1400 VOLTS 240</p>	<p>CH6809 440233</p> <p>Sorry This Item Is No Longer Available</p>  <p>Roper 33-9881; 330313; 331427 WATTS 2800 VOLTS 240</p>
<p>CH4818 458062</p> <p>Sorry This Item Is No Longer Available</p>  <p>Roper/Kenmore 322635 WATTS 1500 VOLTS 240</p>	<p>CH6806 440209</p> <p>Sorry This Item Is No Longer Available</p>  <p>Thermador 20-09-161 WATTS 1400 VOLTS 120</p>	<p>CH6810 440241</p> <p>Sorry This Item Is No Longer Available</p>  <p>Roper 335766 WATTS 2500 VOLTS 250</p>
<p>CH4819 457510</p>  <p>Roper/Kenmore 111214 WATTS 1500 VOLTS 240</p>	<p>CH6807 440217</p>  <p>Whirlpool-Kitchen Aid Chambers D-307047-1; D-307047-2; WW3177251 WATTS 1800/1352 VOLTS 240/208</p>	<p>CH6811 440250</p> <p>Sorry This Item Is No Longer Available</p>  <p>Roper 335000; 330315 WATTS 2100 VOLTS 240</p>



Backer

E

Appliance Parts Cross Reference Catalog



Backer EHP

4700 John Bragg Highway

Murfreesboro, TN 37127

(615) 907-6900

<http://www.backerehp.com>



Backer

Catalog # DA-707

*Cross Reference
Range Elements*



Backer EHP

4700 John Bragg Highway

Murfreesboro, TN 37127

(615) 907-6900

<http://www.backerehp.com>



Backer

Catalog # DA-707

Cross Reference Range Elements

Chromalox MP15U	Chromalox MP21U	Chromalox MP26U
ADMIRAL		
35607-1 36302-1 42082-2 43392-1	35136 36303-1 41007 43392-2	35608-2 42170 43392-3
ATHENS (VESTA)		
E382-034 E382-036 E382-12 P382-19 P382-20 P382-27	E382-037 P382-13	E382-035 P382-23
CHAMBERS		
7429 7429B 7429D 8170B 8170E 8276 8322A 8521 9942 Q14182	7427 7427B 7428 7428B 8171 8323 8324 9943 9946 Q14184 Q14186	7427-D 7428-D
COLUMBUS STOVE		
0483-02-07	0482-03-07	
DWYER		
925-216 925-218	925-217	925-219
ENTERPRISE (PHILLIPS AND BUTTORFF)		
150331	150424 150435	
GAFFERS AND SATTLER		
332-134 332-142 332-145 332-160 332-162	332-135	332-136 332-146 332-161 332-163
GIBSON		
54620 54968	54621	54622 54971 56299
HARDWICK		
OE00600100 OE00600199 OE00600799 OE00600899 OE00600999 OE00601299	OE00800100 OE00800199 OE00800899 OE00801799	OE00801099
JENN AIR		
7031 7456 7727 8097 15927	7457 7728 15928	7032 8098
KELVINATOR		
1168646 1168773 1169198 1189692 1189693 1300711 1300716 1303295 1303296 1303297 1303298 1303299 1308077	1168647 1169199 1189834 1301305	1169200 1169201 1189593 1300709 1300712 1301306 1303300 1303303

Chromalox MP15U	Chromalox MP21U	Chromalox MP26U
MAGIC CHEF		
106S-15M 106S-208V3 106S-208VP 106S-351M 106S-351M 106S-2450M 106S-2530M 106S-3510F 106S-3620M 106S-5210 106S-378M	106E-2530M 106F-450W 106G-15M 106G-351M 106G-2450M 106G-2530M 106G-2550M 106G-3620M 106G-3510F 106G-378M	106G-208V4 106G-208VP 106G-351M
MODERN MAID		
74-6-33 74-6-42 74-6-44 74-6-47X 74-6-48X 74-6-54	74-6-35 74-6-41 74-6-43	74-6-34
NORGE		
42-1741	42-1742	42-1743 42-0293
NUTONE		
C28245 C29079 C29504	C28246 C29503	C29080 C29083
O'KEEFE AND MERRITT		
222L003P02 222L003P05 222L003P07 222L003P08 222L006P03 222L006P04 222L006P07 222L006P08 222L007P01 222L007P02 222T023P03 222T023P04 222T027P01 222T027P02 222T027P03 222T042P01 222T042P03 222T042P05	222L002P01 222L003P01 222L003P03 222T002P03 222T005P01 222T022P05 222T028P01 222T043P01 222T043P03 222T043P04	222L003P04 222L003P06 222T022P06 222T022P12 222T028P02
PERFECTION		
22021G1 47369G1 M22021-17	54621 M22021-19	47371G1 47371G2 54971 M22021-20
PREWAY (KENMORE)		
K7573 K7578 K10004 K10722 K14099	K11976 KY14692	KY14100
ROPER (KENMORE)		
106534 108459 108464 108465 111289 113133 114189 235171 235944 236744 279770 281512	103749 104842 108462 108463 108466 108467 108468 111288 112689 112690 114190 114682	40857 113134 232411 235170 235945 236163 237577 281514
SUNRAY STOVE		
02009 02011 02013 02023 02037 02043	02012 02024 02038	02008 02014 02044

Chromalox MP15U	Chromalox MP21U	Chromalox MP26U
TAPPAN		
222T011P01 222T011P02 222T023P01 222T023P03 222T023P04 222T026P01 222T026P03 222T026P04 222T026P05 222T026P06 222T026P07 222T026P08 222T026P09 222T026P12 222T026P13 222T026P14 222T027P01 222T027P02 222T027P03 222T027P04 222T027P05 222T027P06 222T029R01 222T031P02 222T031P05 222T031P07 222T034P01 222T034P02 222T034P03 222T034P04 222T034P05 222T034P06 222T035R01 222T040P01 222T040P02 222T040P03 222T042P01 222T042P02 222T042P03 222T042P04 222T042P05 222T042P06 222T042P07 222T042P08 222T042P09 222T042P10 222T042P11 222T042P13	222T005D01 222T012P01 222T022P05 222T025P07 222T028P01 222T028P03 222T030R01 222T035P01 222T035P03 222T037R01 222T041P01 222T043P01 222T043P03 222T043P04 222T043P06	222T012P02 222T022P02 222T022P10 222T025P02 222T025P03 222T025P05 222T025P08 222T025P10 222T025P11 222T025P12 222T025P16 222T025P17 222T025P18 222T028P02 222T032P02 222T032P04 222T032P07 222T032P09 222T035P02 222T041P02 222T043P02 222T048P01
THERMADOR		
14-19-162 14-19-185	14-19-159	14-19-186
WASTE KING		
100234 100237 100482 100543 100544 102633 102634 102653 102916 103009 103886 103887	100233 100487 100546 100547 102637 102638 102918	13889 100236 100483 100486 103888
WELBILT		
209-81 209-81-1	209-82	209-82-1
WHIRLPOOL		
244062 244145 256697 256698 256699 263090 263140 263146 263375 263564 263839 266629 306656 306657	244032 256700 256704 263091 263377 263568	131112 256701 256703 256705 256706 263143 263149 263881



Backer

Cross Reference Range Elements

Economy Line

SP12MA	SP21MA	SP12MA	SP21MA	SP12MA	SP21MA	SP12MA	SP21MA
AMANA		HARDWICK STOVE		NORGE		ROPER (Kenmore)	
C2714601	C2714701	OE-006-006-99	OE-008-006-99	42-0289	42-0292	112696	112689
C2725301	C2725401	OE-006-009-99	OE-008-007-99	42-0289	42-0294	630670	112690
ATHENS (Vesta)		OE-006-012-99	OE-008-010-99	NUTONE		630724	630671
E382-32	E382-33		OE-008-017-99	C28244			630725
CHAMBERS		KELVINATOR		O'KEEFE AND MERRITT		SUNRAY	
9934	9935	1300710	1300708	222T031P04	222T036P06	02033-04	02034-04
COLUMBUS STOVE		1303294	1301305	222T032P06	222T032P06	74984-00	74985-00
0483-01	0482-01	KENMORE		PEERLESS ENAMEL		TAPPAN	
ENTERPRISE (Phillips and Buttorff)		46633	26734			222T031P01	222T032P01
150332	150436	46733	47371	PERFECTION		222T031P03	222T032P03
GAFFERS AND SATTLER		K13852	46734	M22021-16	M22021-18	222T031P04	222T032P05
332-151	332-152	112696	47371	47368-G1	47370-G1	222T031P06	222T032P06
GRAY DUDLEY (Royal Chef)		MAGIC CHEF		47368-G2	47370-G2	222T031P12	222T032P08
C8476	C8475	106S-353M	106G353M	PREWAY		WHIRLPOOL	
		106S-358M	106G358M	K13852	K13850	256696	256702
		106S-358M	106G358M	KY13830	KY13829		
		106S-388M	106G388M				
		MODERN MAID					
		74-6-47	74-6-48				

Special G.E., Philco & Westinghouse Units

Single Coil	CH30X218	CH30X219	M15P	M21P	MP411	MP412
	GENERAL ELECTRIC		PHILCO		WESTINGHOUSE	
	WB30X218	WB30X219	2951-40	2951-41	Q212411	Q212412

Double Coil	CH30X341	CH30X342	CH30X354	CH30X356	MC45P	MC80P
	GENERAL ELECTRIC			PHILCO		
	WB30X341	WB30X342	WB30X354	WB30X356	2951-37	2951-38

Microtube Double Coil

Chromalox MC45	Chromalox MC80	Chromalox MC85	Chromalox MC45	Chromalox MC80	Chromalox MC85	Chromalox MC45	Chromalox MC80	Chromalox MC85	
ADMIRAL			KELVINATOR			O'KEEFE & MERRITT			
35187	35188		1187319	1187311	1189563	20056	20057	20055	
ATHENS (VESTA)			1187321	1188715		PERFECTION (Hupp)			
P382-01	P382-03		1187818	1189562		53860	53851		
P382-02	P382-08		KENMORE			PHILCO			
P382-04			K6622	K7574	K7571	182255			
P382-07			K7578			STAR			
CHAMBERS			40546	MAGIC CHEF			6462		
6282	6286		1068-450W			6464			
	6287		106G-450W			TAPPAN			
COLUMBUS STOVE			McGRAW-EDISON			40023352	40023350	85-233-34	
C242-2			11B1E-2		11B2E-2	T723362	T723363		
ENTERPRISE (PHILLIPS AND BUTTORFF)			MODERN MAID			222T015P01	T723386		
150213	150410		74-6-6	74-6-7		222T015P02	222T017P01		
GIBSON			NORGE			WEDGEWOOD			
53860	53861		41-3964	41-3963		512-9	513-14		
	53862		41-3965			512-13			
			41-4307			WHIRLPOOL			
						266630	266158	266626	



Backer

Cross Reference Bake & Broil Elements



Backer EHP

4700 John Bragg Highway

Murfreesboro, TN 37127

(615) 907-6900

<http://www.backerehp.com>



Backer

Catalog # DA-707

Cross Reference

Bake & Broil Elements

OEM Part No.	Type	Revised Part No.	Replacement Cat. No.	PCN
--------------	------	------------------	----------------------	-----

ADMIRAL

34055	Bake	202-870968-001	ROP-T	400485
34905-3	Bake	202-871175-001	ROA-T	400901
34981-2	Bake	202-871899-001	CH590	454221
42202	Bake	202-873822-001	CH624	453131
42413	Broil	029-873833-001	CH671	453270
42491	Broil	029-873832-001	CH670	453261
73225	Bake	202-873813-002	CH584	453093
-	Bake	202-873850-001	CH588	453915

AMANA

C27049-12	Bake	202-872858-001	CH2858	454926
C27341-1	Bake	202-875860-001	CH5860	458564
C44521	Bake	202-873815-001	CH586	453907
A4430001	Bake	202-875860-001	CH5860	458564
A4430002	Bake	202-875860-001	CH5860	458564
852891-1	Broil	029-875871-001	CH5871	458679

ATHENS

P-141-02	Bake	202-871841-002	CH610	453114
P-141-03	Broil	029-873852-001	CH515G3	453018
P-141-05	Bake	202-871841-001	CH611	450976
P-141-08	Bake	202-871839-001	CH807	450589
P-141-14	Broil	029-874882-001	CH4882	457932
P-141-15	Bake	202-874883-001	CH4883	457940
P-141-16	Bake	202-872848-001	CH2848	454459
P-141-17	Bake	202-874881-001	CH4881	456833
P-141-20	Bake	202-873865-001	CH1031	453587
P-141-21	Bake	202-872844-001	CH2844	453851
P-141-22	Bake	202-873865-003	CH1028	453552
P-141-23	Broil	029-873867-001	CH1030	453579
E-141-23	Broil	029-873867-001	CH1030	453579
E-141-024	Bake	202-874885-001	CH4885	457959
E-141-025	Broil	029-874886-001	CH4886	457967
E-141-026	Bake	202-874887-001	CH4887	457975
E-141-029	Bake	202-872833-001	CH2833	456243
E-141-030	Broil	029-874884-001	CH4884	456614
E-141-031	Bake	202-872835-001	CH2835	456251
E-141-033	Broil	029-874888-001	CH4888	457983
P-141-037	Bake	202-875818-001	CH5818	456948
P-141-040	Broil	029-875816-001	CH5816	456921
P-141-041	Bake	202-875819-001	CH5819	456956
P-141-044	Broil	029-875817-001	CH5817	456930

BOSTON STOVE

43-E-4292	Broil	029-874841-001	CH484	456550
43-E-4293	Bake	202-874842-001	CH4842	456569

OEM Part No.	Type	Revised Part No.	Replacement Cat. No.	PCN
--------------	------	------------------	----------------------	-----

BROWN

184-2E1	Broil	029-873891-001	CH681	454563
184-2E2	Bake	202-872834-001	CH627	454264
184-2E4	Bake	202-871881-001	CH633	454053
184-2E7	Broil	029-873892-001	CH682	454571
184-2E28	Bake	202-872826-001	CH680	453827
184-2E29	Bake	202-871858-001	CH1858	453835
184-2E30	Bake	202-871857-001	CH679	453819
184-2E36	Bake	202-872826-001	CH680	453827
184-2E37	Bake	202-871857-001	CH679	453819

CALORIC

42136	Bake	202-872821-001	CH761	456075
42137	Bake	202-875828-001	CH5828	458142
42157	Broil	029-873812-001	CH583	453886
46347	Broil	029-873812-001	CH583	453886
63531	Bake	202-875830-001	CH5830	458169
68038	Broil	029-874840-001	CH4840	456542
68142	Bake	202-874838-001	CH4838	456526
69059	Bake	202-875870-001	CH5870	458660
69060	Bake	202-874838-001	CH4838	456526
69061	Broil	029-874837-001	CH4837	456534
73019	Bake	202-875870-001	CH5870	458660
75247	Broil	029-874839-001	CH4839	456534
88867	Broil	029-874839-001	CH4839	456534
89274	Bake	202-872865-001	CH2865	455179
89276	Broil	029-873841-001	CH815	453448
91222	Bake	202-875870-001	CH5870	458660
92223	Bake	202-874838-001	CH4838	456526
91224	Broil	029-872899-001	CH2899	456059
91378	Broil	029-872899-001	CH2899	456059
31-051644-04-0	Broil	029-875890-001	CH5890	440049
31-051646-04-0	Bake	202-875891-001	CH5891	440057
31-051645-04-0	Bake	202-875893-001	CH5893	440073
31-063531-04	Bake	202-875868-001	CH5868	458644
31-063532-04	Broil	029-875869-001	CH5869	458652

CHAMBERS

Q523-025	Broil	029-874861-001	CH4861	457780
Q523-026	Bake	202-874896-001	CH4896	457801
Q523-028	Broil	029-872837-001	CH2837	456278
Q523-029	Bake	202-872838-001	CH2838	456286
Q523-029	Bake	202-875834-001	CH5834	458134
Q523-031	Broil	029-872839-001	CH2839	456294
Q523-032	Bake	202-872838-001	CH2838	456286
7568-D	Bake	202-871864-001	CH1004	450870
1116	Broil	029-874861-001	CH4861	457780
11117	Mullion	417-874862-001	CH4862	457799
14114	Bake	202-872836-001	CH2836	456260
17468	Broil	029-874861-001	CH4861	457780
17507	Mullion	417-874862-001	CH4862	457799



Backer

Cross Reference

Bake & Broil Elements

OEM Part No.	Type	Revised Part No.	Replacement Cat. No.	PCN
--------------	------	------------------	----------------------	-----

CHAMBERS (continued)

18078	Broil	029-874863-001	CH4863	456382
18079	Bake	202-874864-001	CH4864	456390
22238	Bake	202-872838-001	CH2838	456286
22238	Bake	202-875834-001	CH5834	458134
22239	Broil	029-872837-001	CH2837	456278
126634	Bake	202-874896-001	CH4896	457801
C-305566-1	Broil	029-875849-001	CH5849	458358
C-305566-2	Broil	029-875849-001	CH5849	458358
C-305337-3	Bake	202-876804-001	CH6804	440188
C-305337-4	Bake	202-875834-001	CH5834	458134
C-305337-5	Bake	202-875834-001	CH5834	458134
C-305337-2B	Bake	202-876804-001	CH6804	440188
CC70155	Bake	202-875834-001	CH5834	458134
CC70644A	Bake	202-875834-001	CH5834	458134
CC70662-A	Bake	202-875834-001	CH5834	458134
CC70781	Broil	029-875849-001	CH5849	458358
CC70907	Bake	202-876804-001	CH6804	440188
CC70845	Bake	202-875834-001	CH5834	458134
CC70855	Bake	202-875834-001	CH5834	458134
-	Bake	202-871701-001	ROU-T	403037

COLUMBUS

0186-03	Bake	202-873848-001	CH678	455005
0186-04	Bake	202-873848-002	CH818	453456
0187-02	Broil	029-873879-001	CH527	454184
0187-04	Broil	029-873879-001	CH527	454184
C-241-2	Bake	202-871860-003	CH1001	450790
C-241-3	Bake	202-871860-003	CH1001	450790
0853-01	Broil	029-873846-001	CH816	453595
07399-04	Broil	029-873879-001	CH527	454184

CORNING

981034	Bake	202-873870-001	CH1035	453624
--------	------	----------------	--------	--------

DETROIT JEWELL

-	Bake	202-871861-001	CH557	453860
-	Bake	202-871861-002	CH558	454213
-	Bake	202-871861-003	CH559	453878

DISTINCTIVE APPLIANCE

K14212	Broil	029-874843-001	CH4843	456577
82100-B	Bake	029-874844-001	CH4844	456593

DWYER

KA-90T	Bake	202-872870-001	CH2870	455101
925-012	Bake	202-872870-001	CH2870	455101

OEM Part No.	Type	Revised Part No.	Replacement Cat. No.	PCN
--------------	------	------------------	----------------------	-----

EAGLE

58658	Broil	029-872899-001	CH2899	456059
-------	-------	----------------	--------	--------

ENTERPRISE

150512	Broil	029-873809-001	CH562	453069
150513	Broil	029-873840-001	CH820	454686
150514	Broil	029-872885-001	CH2885	455910
1505141-B	Broil	029-872885-001	CH2885	455910
150515	Broil	029-873887-001	CH3887	454301
150516	Broil	029-873887-001	CH3887	454301
150519	Broil	029-873887-001	CH3887	454301
150522	Broil	029-873840-001	CH820	454686
150609	Broil	029-873805-001	CH3805	454475
150610	Bake	202-873872-001	CH1037	453641
150611	Bake	202-873810-001	CH563	453077
150612	Bake	202-873810-002	CH564	453085
150613	Bake	202-873800-001	CH3800	454440
150614	Bake	202-871856-001	CH694	453801
150615	Bake	202-871852-001	CH707	453763
150617	Bake	202-872894-001	CH780	456008
150618	Bake	202-872895-001	CH781	456016
150621	Bake	202-872894-001	CH780	456008
150622	Bake	202-872895-001	CH781	456016
150624	Bake	202-873872-001	CH1037	453641

FRIGIDAIRE

630743	Broil	029-875821-001	CH5821	456972
630807	Bake	202-875823-001	CH5823	456999
632071	Bake	202-875820-001	CH5820	456964
632073	Bake	202-875820-001	CH5820	456964
632236	Broil	029-875814-001	CH5814	456905
632238	Broil	029-875814-001	CH5814	456905
632248	Broil	029-875814-001	CH5814	456905
632277	Broil	029-875814-001	CH5814	456905
632305	Bake	202-871895-002	CH978	454150
632305	Bake	202-875811-001	CH5811	456876
632306	Bake	202-871895-002	CH978	454150
632306	Bake	202-875811-001	CH5811	456876
632307	Bake	202-874898-001	CH783	456622
632308	Bake	202-874898-001	CH783	456622
632309	Bake	202-875820-001	CH5820	456964
632310	Bake	202-875820-001	CH5820	456964
632311	Bake	202-875820-001	CH5820	456964
632312	Bake	202-875820-001	CH5820	456964
632321	Broil	029-875814-001	CH5814	456905
632335	Broil	029-875810-001	CH5810	456868
632342	Broil	029-875810-001	CH5810	456868
632417	Broil	023-875814-001	CH5814	456905
633110	Bake	202-871820-001	CH960	454344
633112	Bake	202-873886-001	CH695	454299
633114	Bake	202-871895-002	CH978	454150



Backer

Cross Reference

Bake & Broil Elements

OEM Part No.	Type	Revised Part No.	Replacement Cat. No.	PCN
--------------	------	------------------	----------------------	-----

OEM Part No.	Type	Revised Part No.	Replacement Cat. No.	PCN
--------------	------	------------------	----------------------	-----

FRIGIDAIRE (continued)

634706	Bake	202-871896-001	CH979	454168
634706	Bake	202-875820-001	CH5820	456964
634707	Bake	202-875820-001	CH5820	456964
635621	Broil	029-875835-001	CH5835	458214
635623	Broil	029-875836-001	CH5836	458222
635637	Broil	029-875837-001	CH5837	458230
1133051	Bake	202-871895-002	CH978	454150
1133051	Bake	202-875811-001	CH5811	456876
1133052	Bake	202-874898-001	CH783	456622
1133272	Bake	202-872841-001	CH964	454379
1133474	Bake	202-875820-001	CH5820	456964
5429818	Bake	202-872830-001	CH959	456155
5431532	Bake	202-871816-001	CH968	451207
5431591	Bake	202-871816-001	CH968	451207
5431868	Bake	202-871816-001	CH968	451207
5432061	Bake	202-871816-001	CH968	451207
5432062	Bake	202-871816-001	CH968	451207
5432063	Bake	202-871816-001	CH968	451207
5432223	Bake	202-871836-001	CH965	454387
5432263	Broil	029-871837-001	CH972	454395
5432675	Bake	202-871816-001	CH968	451207
5432679	Bake	202-871816-001	CH968	451207
5432683	Bake	202-871816-001	CH968	451207
5432976	Bake	202-871816-001	CH968	451207
5439369	Broil	029-871818-001	CH970	454133
5439402	Broil	029-871818-001	CH970	454133
5439493	Broil	029-871837-001	CH972	454395
5439497	Broil	029-871837-001	CH972	454395
5439572	Broil	029-871837-001	CH972	454395
5439601	Bake	202-871816-001	CH968	451207
5439827	Bake	202-871816-001	CH968	451207
6560769	Bake	202-871821-001	CH975	451127
6560890	Broil	029-871818-001	CH970	454133
6560891	Broil	029-871818-001	CH970	454133
6561553	Bake	202-871817-001	CH969	454125
6562551	Broil	029-872808-001	CH973	454707
6562584	Bake	202-871821-001	CH975	451127
6563301	Broil	029-872810-001	CH976	454723
6563765	Broil	029-871819-001	CH971	454141
6564003	Bake	202-871821-001	CH975	451127
6564391	Broil	029-871819-001	CH971	454141
6564632	Bake	202-871832-001	CH961	454352
6564694	Bake	202-871834-001	CH963	454360
6564754	Bake	202-875815-001	CH5815	456913
6564765	Broil	029-872809-001	CH974	454715
6564823	Broil	202-875813-001	CH5813	456892
7520969	Bake	202-871832-001	CH961	454352
7520991	Bake	202-871834-001	CH963	454360
7521393	Bake	202-871832-001	CH961	454352
7521397	Bake	202-871832-001	CH961	454352
7521900	Bake	202-871834-001	CH963	454360
7521905	Bake	202-871834-001	CH963	454360

FRIGIDAIRE (continued)

7522312	Broil	029-875892-001	CH5892	440065
7522760	Broil	029-872811-001	CH977	454731
7523311	Bake	202-875815-001	CH5815	456913
7523774	Broil	029-871819-001	CH971	454141
7523839	Broil	029-872810-001	CH976	454723
7524069	Bake	202-871817-001	CH969	454125
7524073	Broil	029-871819-001	CH971	454141
7524074	Broil	029-871819-001	CH971	454141
7524679	Broil	029-871837-001	CH972	454395
7524680	Broil	029-871837-001	CH972	454395
7524681	Broil	029-872810-001	CH976	454723
7524682	Broil	029-872810-001	CH976	454723
7524683	Broil	029-872811-001	CH977	454731
7524684	Broil	029-872811-001	CH977	454731
7524685	Broil	029-871818-001	CH970	454133
7524686	Broil	029-871818-001	CH970	454133
7524688	Broil	029-872808-001	CH973	454707
7524691	Bake	202-871821-001	CH975	451127
7525588	Broil	029-872807-001	CH962	454694
7525589	Broil	029-875822-001	CH5822	456980
7525591	Broil	029-875822-001	CH5822	456980
7525606	Broil	029-872807-001	CH962	454694
7525607	Broil	029-875822-001	CH5822	456980
7525622	Broil	029-871819-001	CH971	454141
7525629	Broil	029-871819-001	CH971	454141
7525706	Bake	202-871896-001	CH979	454168
7525706	Bake	202-875820-001	CH5820	456964
7525769	Bake	202-871895-002	CH978	454150
7525769	Bake	202-875811-001	CH5811	456876
7525781	Bake	202-871895-002	CH978	454150
7525781	Bake	202-875811-001	CH5811	456876
7525864	Bake	202-871893-001	CH966	454109
7525867	Bake	202-871894-001	CH967	454117
7526005	Bake	202-872841-001	CH964	454379
7526298	Broil	029-871819-001	CH971	454141
7526489	Bake	202-871820-001	CH960	454344
7526491	Bake	202-871895-002	CH978	454150
7526492	Bake	202-871895-002	CH978	454150
7526493	Bake	202-872801-001	CH705	454619
7526493	Bake	202-873886-001	CH695	454299
7526494	Bake	202-873886-001	CH695	454299
7526592	Broil	029-872807-001	CH962	454694
7526594	Broil	029-872807-001	CH962	454694
7526597	Broil	029-871819-001	CH971	454141
7526598	Broil	029-871819-001	CH971	454141
7526601	Broil	029-871819-001	CH971	454141
7526602	Bake	202-871895-002	CH978	454150
7526602	Bake	202-875811-001	CH5811	456876
7526605	Bake	202-871894-001	CH967	454117
7526607	Bake	202-871896-001	CH979	454168
7526607	Bake	202-875820-001	CH5820	456964
7526610	Bake	202-871893-001	CH966	454109



Backer

Cross Reference Bake & Broil Elements

OEM Part No.	Type	Revised Part No.	Replacement Cat. No.	PCN
--------------	------	------------------	----------------------	-----

FRIGIDAIRE (continued)

7527198	Broil	029-872807-001	CH962	454694
7531226	Broil	029-872810-001	CH976	454723
7531230	Bake	202-874898-001	CH783	456622
7531324	Broil	029-872807-001	CH962	454694
7531325	Broil	029-872807-001	CH962	454694
7531326	Broil	029-872807-001	CH962	454694
7531329	Broil	029-871819-001	CH971	454141
7531340	Broil	029-872810-001	CH976	454723
7531806	Broil	029-871819-001	CH971	454141
7531825	Bake	202-874898-001	CH783	456622
7531869	Broil	029-871819-001	CH971	454141
7532550	Bake	202-872841-001	CH964	454379
7532552	Bake	202-871820-001	CH960	454344
7532553	Bake	202-871820-001	CH960	454344
7532554	Bake	202-873886-001	CH695	454299
7532555	Bake	202-873886-001	CH695	454299
7532556	Bake	202-871895-002	CH978	454150
7532557	Bake	202-871895-002	CH978	454150
7533577	Bake	202-871817-001	CH969	454125
7534352	Bake	202-875823-001	CH5823	456999
8002856	Broil	029-874874-001	CH4874	457908
8002858	Bake	202-872892-001	CH775	455988
8002859	Bake	202-874898-001	CH783	456622
8003347	Bake	202-872892-001	CH775	455988
8004202	Bake	202-871895-002	CH978	454150
8008245	Bake	202-874879-001	CH4879	458003
8008263	Bake	202-872823-001	CH776	456091
9950885	Bake	202-875811-001	CH5811	456876
9950886	Bake	202-874898-001	CH783	456622
9950887	Bake	202-875820-001	CH5820	456964
9950888	Bake	202-871821-001	CH975	451127
9950889	Bake	202-871894-001	CH967	454117
9950890	Bake	202-871893-001	CH966	454109
9950891	Bake	202-871817-001	CH969	454125
9950925	Bake	202-871834-001	CH963	454360
9950932	Broil	029-875835-001	CH5835	458214
N9951510	Broil	029-875889-001	CH5889	440030
9951511	Broil	029-872807-001	CH962	454694
9951514	Bake	202-871893-001	CH966	454109
9951515	Bake	202-871817-001	CH969	454125
9951525	Broil	029-875814-001	CH5814	456905
9951539	Broil	029-875835-001	CH5835	458214
9951540	Broil	029-875836-001	CH5836	458222
5303051516	Broil	029-874874-001	CH4874	457908

G.R.

221G003P01	Bake	202-875887-001	CH5887	440014
220G004P01	Broil	029-875896-001	CH5896	440102

OEM Part No.	Type	Revised Part No.	Replacement Cat. No.	PCN
--------------	------	------------------	----------------------	-----

GAFFERS & SATTLER

332-5	Bake	202-872879-001	CH672	455857
332-10	Broil	029-873878-001	CH591	453384
332-12	Bake	202-872898-001	CH714	456040
332-181	Broil	029-873878-001	CH591	453384
332-191	Bake	202-872879-001	CH672	455857
332-196C	Broil	029-873878-001	CH591	453384
332-201	Bake	202-872879-001	CH672	455857
332-202	Bake	202-872879-001	CH672	455857
332-203	Bake	202-872879-001	CH672	455857

GEMLINE

RP515	Broil	-	CH515	453000
RP515G3	Broil	-	CH515G3	453018
RP518	Bake	-	CH518	455902
RP527	Broil	-	CH527	454184
RP528	Bake	-	CH528	453026
RP550	Bake	-	CH550	453034
RP551	Bake	-	ROU-N	400506
RP552	Bake	-	CH44X5021	454205
RP554	Broil	-	CH554	453042
RP555	Bake	-	CH555	456104
RP556	Bake	-	CH556	453739
RP557	Bake	-	CH557	453860
RP558	Bake	-	CH558	454213
RP559	Bake	-	CH559	453878
RP560	Bake	-	CH595	453051
RP562	Broil	-	CH562	453069
RP563	Bake	-	CH563	453077
RP564	Bake	-	CH564	453085
RP565	Bake	-	ROP-N	400477
RP571	Bake	-	CH44X163	451637
RP572	Bake	-	CH45X5008	450562
RP573	Bake	-	ROA-N	400400
RP574	Bake	-	ROA-W	400418
RP575	Broil	-	RTA	400522
RP576	Broil	-	RTP	400549
RP577	Bake	-	ROP-N	400477
RP579	Broil	-	RTU	400557
RP580	Bake	-	ROU-N	400506
RP581	Bake	-	ROP-T	400485
RP583	Broil	-	CH583	453886
RP584	Bake	-	CH584	453093
RP585	Broil	-	CH585	453894
RP586	Bake	-	CH586	453907
RP587	Bake	-	CH587	453958
RP588	Bake	-	CH588	453915
RP590	Bake	-	CH590	454221
RP591	Broil	-	CH591	453384
RP592	Bake	-	CH592	453931
RP593	Broil	-	CH593	452103
RP594	Bake	-	CH594	454002



Backer

Cross Reference

Bake & Broil Elements

OEM Part No.	Type	Revised Part No.	Replacement Cat. No.	PCN
--------------	------	------------------	----------------------	-----

OEM Part No.	Type	Revised Part No.	Replacement Cat. No.	PCN
--------------	------	------------------	----------------------	-----

GEMLINE (continued)

RP595	Bake	-	CH595	453051
RP596	Bake	-	CH596	454010
RP597	Bake	-	CH597	454029
RP598	Broil	-	CH1019	451850
RP601	Broil	-	CH601	451928
RP606	Bake	-	CH2854	454889
RP607	Bake	-	CH590	454221
RP608	Bake	-	CH608	454256
RP609	Bake	-	CH609	454045
RP610	Bake	-	CH610	453114
RP611	Bake	-	CH611	450976
RP612	Broil	-	CG612	451821
RP613	Bake	-	CH613	450757
RP616	Bake	-	CH613	450757
RP617	Broil	-	CH617	453122
RP618	Bake	-	CH625	450749
RP619	Broil	-	CH619	451725
RP620	Bake	-	CH620	453843
RP621	Broil	-	CH621	451901
RP622	Broil	-	CH622	451709
RP624	Bake	-	CH624	453131
RP625	Bake	-	CH625	450749
RP626	Bake	-	CH626	450714
RP627	Bake	-	CH627	454264
RP628	Bake	-	CH628	453481
RP629	Bake	-	CH629	453149
RP631	Bake	-	CH624	453131
RP632	Broil	-	CH632	453157
RP633	Bake	-	CH633	454053
RP635	Broil	-	CH635	454993
RP636	Broil	-	CH636	454272
RP637	Bake	-	CH637	454547
RP638	Broil	-	CH638	453165
RP639	Broil	-	CH639	454985
RP640	Bake	-	CH640	454061
RP641	Bake	-	CH641	453237
RP642	Broil	-	CH642	453392
RP643	Bake	-	CH643	454070
RP644	Bake	-	CH644	454520
RP645	Bake	-	CH645	455021
RP646	Broil	-	CH646	453501
RP648	Bake	-	CH648	451514
RP649	Bake	-	CH649	451506
RP650	Bake	-	CH650	451303
RP651	Bake	-	CH651	451400
RP652	Bake	-	CH652	451311
RP653	Bake	-	CH653W	455187
RP654	Bake	-	CH654	451004
RP655	Bake	-	CH655	453181
RP655W	Bake	-	CH655W	450950
RP656	Bake	-	CH656	453190
RP656W	Bake	-	CH656W	450968

GEMLINE (continued)

RP659	Broil	-	CH659	453923
RP660	Bake	-	CH660	453202
RP661	Bake	-	CH661	453211
RP662	Bake	-	CH662	453229
RP663	Bake	-	CH625	450749
RP664	Bake	-	CH664	453245
RP665	Bake	-	CH665	453253
RP670	Broil	-	CH670	453261
RP671	Broil	-	CH671	453270
RP672	Bake	-	CH672	455857
RP673	Bake	-	CH673	453683
RP674	Broil	-	CH3887	454301
RP675	Bake	-	CH675	454432
RP676	Broil	-	CH676	453747
RP677	Broil	-	CH677	454555
RP678	Bake	-	CH678	455005
RP679	Bake	-	CH679	453819
RP680	Bake	-	CH680	453827
RP681	Broil	-	CH681	454563
RP682	Broil	-	CH682	454571
RP683	Bake	-	CH683	454580
RP684	Broil	-	CH684	453755
RP685	Bake	-	CH685	453798
RP687	Bake	-	CH687	453721
RP688	Broil	-	CH3801	454467
RP689	Bake	-	CH1006	452200
RP690	Broil	-	CH671	453270
RP691	Bake	-	CH691	453288
RP693	Bake	-	CH693	453296
RP694	Bake	-	CH694	453801
RP696	Bake	-	CH696	453309
RP697	Bake	-	CH697	454803
RP698	Bake	-	CH698	453317
RP699	Broil	-	CH699	453325
RP700	Bake	-	CH700	453333
RP701	Bake	-	CH1004	450870
RP702	Bake	-	ROU-T	403037
RP705	Bake	-	CH705	454619
RP706	Broil	-	CH3887	454301
RP707	Bake	-	CH707	453763
RP708	Broil	-	CH708	454627
RP709	Bake	-	CH709	454635
RP712	Bake	-	CH712	454651
RP713	Bake	-	CH713	454660
RP714	Bake	-	CH714	456040
RP715	Bake	-	CH679	453819
RP716	Bake	-	CH2864	455152
RP717	Bake	-	CH2865	455179
RP718	Bake	-	CH2866	455080
RP720	Broil	-	CH2867	455072
RP722	Broil	-	CH2899	456059
RP724	Broil	-	CH2869	455099



Backer

Cross Reference

Bake & Broil Elements

OEM Part No.	Type	Revised Part No.	Replacement Cat. No.	PCN
--------------	------	------------------	----------------------	-----

OEM Part No.	Type	Revised Part No.	Replacement Cat. No.	PCN
--------------	------	------------------	----------------------	-----

GEMLINE (continued)

RP725	Bake	-	CH2820	456067
RP727	Bake	-	CH2860	454820
RP728	Broil	-	CH2871	455110
RP729	Broil	-	CH1030	453579
RP731	Bake	-	CH2872	455123
RP732	Broil	-	CH2873	455136
RP733	Broil	-	CH591	453384
RP734	Bake	-	CH1001	450790
RP736	Broil	-	CH1003	451741
RP737	Broil	-	CH1027	453544
RP738	Bake	-	CH1040	453675
RP739	Bake	-	CH1005	450802
RP740	Broil	-	CH1039	453667
RP741	Bake	-	CH1006	452200
RP743	Bake	-	CH1011	450861
RP744	Bake	-	CH1012	450722
RP745	Bake	-	CH1031	453587
RP746	Broil	-	CH1020	453499
RP747	Bake	-	CH1025	453528
RP748	Bake	-	CH1026	453536
RP749	Bake	-	CH1016	450706
RP750	Broil	-	CH1042	453691
RP751	Broil	-	CH1044	453712
RP752	Bake	-	CH2857	454918
RP753	Broil	-	CH1036	453632
RP758	Bake	-	CH1028	453552
RP759	Broil	-	CH759	455873
RP760	Broil	-	CH3839	454176
RP761	Bake	-	CH761	456075
RP762	Broil	-	CH1024	453510
RP763	Broil	-	CH2850	454977
RP764	Bake	-	CH764	453341
RP765	Bake	-	CH2822	456083
RP768	Bake	-	CH1015	450765
RP769	Broil	-	CH1019	451805
RP770	Broil	-	CH5871	458679
RP771	Bake	-	CH1035	453624
RP772	Broil	-	CH1043	453704
RP774	Broil	-	CH2891	455970
RP775	Bake	-	CH775	455988
RP776	Bake	-	CH776	456091
RP777	Bake	-	CH2858	454926
RP778	Bake	-	CH687	453721
RP779	Broil	-	CH779	455996
RP780	Bake	-	CH780	456008
RP781	Bake	-	CH781	456016
RP782	Bake	-	CH1858	453835
RP783	Bake	-	CH783	456622
RP785	Bake	-	CH596	454070
RP786	Bake	-	CH2833	456243
RP787	Broil	-	CH4884	456614

GEMLINE (continued)

RP789	Broil	-	CH2859	454934
RP790	Bake	-	CH4836	456500
RP791	Bake	-	CH5870	458660
RP792	Bake	-	CH4825	456770
RP793	Broil	-	CH4826	457860
RP794	Broil	-	CH4839	456534
RP795	Bake	-	CH5828	458142
RP796	Broil	-	CH5835	458214
RP797	Broil	-	CH5837	458230
RP798	Bake	-	CH5830	458169
RP799	Bake	-	CH2851	454854
RP802	Bake	-	CH802	456147
RP805	Bake	-	CH805	453350
RP807	Bake	-	CH807	450589
RP808	Broil	-	CH808	452111
RP809	Bake	-	CH809	450730
RP812	Bake	-	CH812	453421
RP813	Bake	-	CH813	450810
RP814	Bake	-	CH814	453430
RP815	Broil	-	CH815	453448
RP816	Broil	-	CH816	453595
RP818	Bake	-	CH818	453456
RP823	Broil	-	CH4843	456577
RP824	Broil	-	CH824	454790
RP825	Bake	-	CH825	453771
RP826	Broil	-	CH826	455865
RP828	Bake	-	CH4825	456770
RP829	Broil	-	CH4874	457908
RP830	Broil	-	CH4821	457561
RP831	Broil	-	CH4826	457860
RP832	Bake	-	CH4896	457801
RP833	Broil	-	CH4845	457633
RP834	Bake	-	CH4880	456745
RP835	Broil	-	CH4847	457545
RP836	Bake	-	CH4853	457570
RP837	Bake	-	CH4879	458003
RP838	Bake	-	CH4854	457596
RP839	Bake	-	CH4893	457836
RP840	Bake	-	CH4892	457828
RP841	Bake	-	CH2860	454820
RP842	Bake	-	CH5818	456948
RP843	Broil	-	CH5816	456921
RP844	Broil	-	CH5814	456905
RP845	Bake	-	CH5823	456999
RP846	Broil	-	CH5813	456892
RP848	Bake	-	CH4875	456737
RP849	Broil	-	CH4822	457764
RP850	Bake	-	CH4856	457668
RP851	Broil	-	CH4826	457860
RP853	Bake	-	CH679	453819
RP854	Broil	-	CH5846	458329
RP855	Bake	-	CH4833	456470



Backer

Cross Reference

Bake & Broil Elements

OEM Part No.	Type	Revised Part No.	Replacement Cat. No.	PCN
--------------	------	------------------	----------------------	-----

OEM Part No.	Type	Revised Part No.	Replacement Cat. No.	PCN
--------------	------	------------------	----------------------	-----

GEMLINE (continued)

RP856	Bake	-	CH5829	458150
RP862	Broil	-	CH5855	458548
RP871	Bake	-	CH5853	458521
RP956	Bake	-	CH956	450520
RP958	Bake	-	CH958	450511
RP959	Bake	-	CH959	456155
RP960	Bake	-	CH960	454344
RP961	Bake	-	CH961	454352
RP962	Broil	-	CH962	454694
RP963	Bake	-	CH963	454360
RP964	Bake	-	CH964	454379
RP965	Bake	-	CH965	454387
RP966	Bake	-	CH966	454109
RP967	Bake	-	CH967	454117
RP968	Bake	-	CH968	451207
RP969	Bake	-	CH969	454125
RP970	Broil	-	CH970	454133
RP971	Broil	-	CH971	454141
RP972	Broil	-	CH972	454395
RP974	Broil	-	CH974	454715
RP975	Bake	-	CH975	451127
RP976	Broil	-	CH976	454723
RP977	Broil	-	CH977	454731
RP978	Bake	-	CH978	454150
RP979	Bake	-	CH979	454168
RP980	Bake	-	CH44X5019	451119
RP981	Bake	-	CH44X5043	454280
RP982	Bake	-	CH44X142	451629
RP983	Broil	-	CH44X5006	454774
RP985	Broil	-	CH44X5045	453780
RP986	Broil	-	CH45X5020	454838
RP987	Broil	-	CH987	453472
RP44X126	Bake	-	CH44X126	450546
RP44X127	Bake	-	CH44X196	458310
RP44X134	Broil	-	CH44X134	454096
RP44X136	Broil	-	CH44X136	454512
RP44X142	Bake	-	CH44X142	451629
RP44X160	Bake	-	CH44X200	458290
RP44X164	Bake	-	CH44X164	453173
RP44X165	Bake	-	CH44X165	454740
RP44X169	Bake	-	CH44X169	454766
RP44X170	Bake	-	CH44X170	454491
RP44X173	Broil	-	CH44X185	458302
RP44X185	Broil	-	CH44X185	458302
RP44X200	Bake	-	CH44X200	458290
RP44X5043	Bake	-	CH44X5043	454280
RP44X5074	Broil	-	CH44X5074	458185
RP44X5082	Bake	-	CH44X5082	458193
RP44X5083	Bake	-	CH44X5083	458206
RP44X5099	Bake	-	CH44X5099	454811
RP45X50	Bake	-	CH45X50	451135
RP45X56	Bake	-	CH45X56	452007
RP45X58	Bake	-	CH44X142	451629

GENERAL ELECTRIC

WB44X2	Bake	202-871829-001	CH44X142	451629
WB44X4	Bake	202-871829-001	CH44X142	451629
WB44X6	Bake	202-871829-001	CH44X142	451629
WB44X67	Bake	202-871829-001	CH44X142	451629
WB44X94	Bake	202-871829-001	CH44X142	451629
WB44X105	Bake	202-871825-002	CH44X126	450546
WB44X105	Bake	202-872818-001	CH44X5099	454811
WB44X108	Broil	029-871828-001	CH45X56	452007
WB44X109	Bake	202-875845-001	CH44X196	458310
WB44X110	Bake	202-875845-001	CH44X196	458310
WB44X112	Bake	202-871825-002	CH44X126	450546
WB44X113	Bake	202-875845-001	CH44X196	458310
WB44X114	Bake	202-875845-001	CH44X196	458310
WB44X116	Broil	029-871828-001	CH45X56	452007
WB44X118	Bake	202-871825-002	CH44X126	450546
WB44X118	Bake	202-872818-001	CH44X5099	454811
WB44X120	Bake	202-871825-002	CH44X126	450546
WB44X120	Bake	202-872818-001	CH44X5099	454811
WB44X123	Bake	202-875845-001	CH44X196	458310
WB44X124	Bake	202-875845-001	CH44X196	458310
WB44X126	Bake	202-871825-002	CH44X126	450546
WB44X126	Bake	202-872818-001	CH44X5099	454811
WB44X127	Bake	202-875845-001	CH44X196	458310
WB44X128	Bake	202-875845-001	CH44X196	458310
WB44X131	Bake	202-875845-001	CH44X196	458310
WB44X132	Bake	202-875845-001	CH44X196	458310
WB44X133	Bake	202-871825-002	CH44X126	450546
WB44X133	Bake	202-872818-001	CH44X5099	454811
WB44X134	Broil	029-871898-001	CH44X134	454096
WB44X136	Broil	029-873820-001	CH44X136	454512
WB44X142	Bake	202-871829-001	CH44X142	451629
WB44X149	Broil	029-875844-001	CH44X185	458302
WB44X150	Broil	029-875844-001	CH44X185	458302
WB44X160	Bake	202-875843-001	CH44X200	458290
WB44X163	Bake	202-871800-001	CH44X163	451637
WB44X164	Bake	202-872803-001	CH44X164	453173
WB44X165	Bake	202-872812-001	CH44X165	454740
WB44X167	Broil	029-875844-001	CH44X185	458302
WB44X168	Broil	029-875844-001	CH44X185	458302
WB44X169	Bake	202-872814-001	CH44X169	454766
WB44X170	Bake	202-873818-001	CH44X170	454491
WB44X173	Broil	029-875844-001	CH44X185	458302
WB44X180	Broil	029-872816-001	CH44X180	454782
WB44X185	Broil	029-875844-001	CH44X185	458302
WB44X196	Bake	202-875845-001	CH44X196	458310
WB44X200	Bake	202-875843-001	CH44X200	458290
WB44X230	Bake	202-875853-001	CH5853	458521
WB44X232	Broil	029-875899-001	CH5899	440137
WB44X236	Broil	029-875826-001	CH5826	458038
WB44X237	Bake	202-875894-001	CH5894	440081
WB44X5006	Broil	029-872815-001	CH44X5006	454774
WB44X5019	Bake	202-871822-001	CH44X5019	451119
WB44X5021	Bake	202-873881-001	CH44X5021	454205



Backer

Cross Reference

Bake & Broil Elements

OEM Part No.	Type	Revised Part No.	Replacement Cat. No.	PCN
--------------	------	------------------	----------------------	-----

GENERAL ELECTRIC (continued)

WB44X5025	Bake	202-872819-001	CH44X5025	454846
WB44X5028	Bake	202-872819-001	CH44X5025	454846
WB44X5043	Bake	202-873885-001	CH44X5043	454280
WB44X5044	Bake	202-872856-001	CH44X5044	454900
WB44X5045	Broil	029-871854-001	CH44X5045	453780
WB44X5049	Bake	202-873885-001	CH44X5043	454280
WB44X5050	Bake	202-872856-001	CH44X5044	454900
WB44X5061	Bake	202-875832-001	CH44X5082	458193
WB44X5063	Broil	029-872816-001	CH44X180	454782
WB44X5064	Broil	029-875844-001	CH44X185	458302
WB44X5072	Bake	202-875832-001	CH44X5082	458193
WB44X5074	Broil	029-875831-001	CH44X5074	458185
WB44X5078	Bake	202-873885-001	CH44X5043	454280
WB44X5079	Bake	202-872856-001	CH44X5044	454900
WB44X5080	Bake	202-873885-001	CH44X5043	454280
WB44X5081	Bake	202-872856-001	CH44X5044	454900
WB44X5082	Bake	202-875832-001	CH44X5082	458193
WB44X5083	Bake	202-875833-001	CH44X5083	458206
WB44X5084	Bake	202-872856-001	CH44X5044	454900
WB44X5085	Bake	202-875833-001	CH44X5083	458206
WB44X5099	Bake	202-872818-001	CH44X5099	454811
WB45X2	Bake	202-871801-001	CH45X5008	450562
WB45X3	Bake	202-871829-001	CH44X142	451629
WB45X23	Bake	202-871826-001	CH45X30	452015
WB45X30	Bake	202-871826-001	CH45X30	452015
WB45X50	Bake	202-871827-001	CH45X50	451135
WB45X56	Broil	029-871828-001	CH45X56	452007
WB45X58	Bake	202-871801-001	CH45X5008	450562
WB45X5008	Bake	202-871801-001	CH45X5008	450562
WB45X5020	Broil	029-873880-001	CH45X5020	454838
WB45X5021	Bake	202-871826-001	CH45X30	452015

GIBSON

39542	Bake	202-871803-001	CH620	453843
Y-39672	Bake	202-871812-001	CH656	453190
41035	Bake	202-871803-001	CH620	453843
Y-41036	Bake	202-871812-001	CH656	463190
43819	Bake	202-873815-001	CH586	453907
43820	Broil	029-873814-001	CH585	453894
C-44521	Bake	202-873815-001	CH586	453907
54017	Bake	202-873815-001	CH586	453907
54066	Bake	202-871700-002	ROU-N	400506
54480	Bake	202-873815-001	CH586	453907
54481	Broil	029-873814-001	CH585	453894
54706	Broil	029-873814-001	CH585	453894
54878	Bake	202-871700-002	ROU-N	400506
55322	Broil	029-873814-001	CH585	453894

GRAY & DUDLEY/ROYAL CHEF

1533	Bake	202-872857-001	CH1037	453641
1533	Bake	202-872857-001	CH2857	454918
C-3125	Bake	202-871840-001	CH1840	454408

OEM Part No.	Type	Revised Part No.	Replacement Cat. No.	PCN
--------------	------	------------------	----------------------	-----

GRAY & DUDLEY/ROYAL CHEF (continued)

C-8477	Broil	029-873871-001	CH1036	453632
C-8478	Bake	202-873872-001	CH1037	453641
8743	Bake	202-873872-001	CH1037	453641
	Bake	202-872857-001	CH2857	454918

HARDWICK

OE-001-050	Bake	202-875862-001	CH5862	458580
OE-001-002-00	Bake	202-871865-001	CH1005	450802
OE-001-016-99	Bake	202-872846-001	CH2846	456340
OE-001-031-00	Bake	202-873855-001	CH698	453317
OE-001-031-99	Bake	202-873855-001	CH698	453317
OE-001-032-99	Bake	202-872845-001	CH2845	456331
OE-001-038-99	Bake	202-872876-001	CH2876	455160
OE-001-041-99	Bake	202-872845-001	CH2845	456331
OE-001-042-99	Bake	202-872846-001	CH2846	456340
OE-001-044-99	Bake	202-872845-001	CH2845	456331
OE-001-045-99	Bake	202-872846-001	CH2846	456340
OE-001-048-99	Bake	202-872876-001	CH2876	455160
OE-002-003-99	Broil	029-872840-001	CH2840	456307
OE-002-013-99	Broil	029-873874-001	CH1039	453667
OE-002-021-99	Broil	029-873856-001	CH699	453325
OE-002-156-99	Broil	029-872842-001	CH2842	456315
OE-002-159-99	Broil	029-872862-001	CH2862	456358
OE-002-160-99	Broil	029-872840-001	CH2840	456307
OE-002-163-99	Broil	029-873874-001	CH1039	453667
OE-002-166-99	Broil	029-872842-001	CH2842	456315
OE-002-168-99	Broil	029-872862-001	CH2862	456358
OE-002-170-99	Broil	029-876802-001	CH6802	440161
OE-002-171-99	Broil	029-875861-001	CH5861	458572
OE-002-172-99	Broil	029-875861-001	CH5861	458572

HOTPOINT

600163	Bake	202-871829-001	CH44X142	451629
650040	Bake	202-871829-001	CH44X142	451629
650324	Broil	029-872815-001	CH44X5006	454774
660163	Bake	202-871829-001	CH44X142	451629
660885	Bake	202-871829-001	CH44X142	451629
661095	Bake	202-873881-001	CH44X5021	454205
661160	Bake	202-871822-001	CH44X5019	451119
661352	Bake	202-871822-001	CH44X5019	451119
661698	Bake	202-871829-001	CH44X142	451629
661731	Bake	202-871822-001	CH44X5019	451119
661782	Broil	029-873880-001	CH45X5020	454838
662300	Bake	202-873881-001	CH44X5021	454205
662368	Broil	029-873880-001	CH45X5020	454838
662385	Bake	202-871826-001	CH45X30	452015
663130	Bake	202-873885-001	CH44X5043	454280
663132	Bake	202-872819-001	CH44X5025	454846
663134	Bake	202-875845-001	CH44X196	458310
663800	Broil	029-871854-001	CH44X5045	453780
663802	Broil	029-871854-001	CH44X5045	453780
664640	Bake	202-873885-001	CH44X5043	454280



Backer

Cross Reference

Bake & Broil Elements

OEM Part No.	Type	Revised Part No.	Replacement Cat. No.	PCN
--------------	------	------------------	----------------------	-----

OEM Part No.	Type	Revised Part No.	Replacement Cat. No.	PCN
--------------	------	------------------	----------------------	-----

HOTPOINT (continued)

664641	Bake	202-872856-001	CH44X5044	454900
664644	Broil	029-871854-001	CH44X5045	453780
664729	Bake	202-873885-001	CH44X5043	454280
664730	Bake	202-872856-001	CH44X5044	454900

JENN-AIRE

109305	Bake	202-873845-001	CH814	453430
239119	Bake	202-873845-001	CH814	453430
201767	Bake	202-874836-001	CH4836	456500
202550	Bake	202-874836-001	CH4836	456500
202551	Broil	029-875888-001	CH5888	440022
302249	Bake	202-873845-001	CH814	453430
15416	Broil	029-876801-001	CH6801	440153
715269	Broil	202-876800-001	CH6800	440145

KELVINATOR

1081520	Broil	029-871892-001	CH619	451725
1143907	Broil	029-871848-003	CH658	451733
1168623	Bake	202-871803-001	CH620	453843
1181598	Bake	202-871802-001	CH616	450773
1185307	Bake	202-871847-001	CH657	451223
1186441	Broil	029-873817-001	CH605	454037
1187527	Bake	202-871813-001	CH656W	450968
1187528	Bake	202-871811-001	CH655W	450950
1187761	Bake	202-871813-001	CH656W	450968
1188705	Bake	202-871813-001	CH656W	450968
1188706	Bake	202-871811-001	CH655W	450950
1188746	Broil	029-871850-001	CH824	454790
1188747	Broil	029-871850-001	CH824	454790
1300718	Bake	202-873823-005	CH629	453149
1300899	Broil	029-873826-001	CH659	453923
1301720	Bake	202-871840-001	CH1840	454408
1301722	Broil	029-873879-001	CH527	454184
1302026	Broil	029-873826-001	CH659	453923
1303549	Bake	202-873875-001	CH1040	453675
1303562	Bake	202-872865-001	CH2865	455179
1303580	Broil	029-873841-001	CH815	453448
1303582	Broil	029-873842-001	CH821	453464
1305816	Broil	029-874870-001	CH4870	456753
1305816-D	Broil	029-874870-001	CH4870	456753
1306254	Broil	029-874871-001	CH4871	457991
1307475	Bake	202-872865-001	CH2865	455179
1308773	Broil	029-873866-001	CH1029	453561
1309020	Broil	029-874872-001	CH4872	457887
1310050-D	Broil	029-872891-001	CH2891	455970
1310051	Broil	029-874873-001	CH4873	457895
1310236	Broil	029-873866-001	CH1029	453561
1311292	Broil	029-874874-001	CH4874	457908
1311298-D	Bake	202-872892-001	CH775	455988
1311493	Bake	202-874875-001	CH4875	456737
1311494	Bake	202-874876-001	CH4876	456729

KELVINATOR (continued)

1311770	Broil	029-874877-001	CH4877	457916
1312852	Bake	202-874878-001	CH4878	457924
1312853	Bake	202-872892-001	CH775	455988
1312854	Bake	202-874878-001	CH4878	457924
1313169	Bake	202-874879-001	CH4879	458003
1313170	Bake	202-874880-001	CH4880	456745
1313171	Bake	202-874879-001	CH4879	458003
1313172	Bake	202-874880-001	CH4880	456745

KENMORE

3460	Broil	029-873852-001	CH515G3	453018
3462	Bake	202-871841-001	CH611	450976
5321	Bake	202-871839-001	CH807	450589
5375	Bake	202-874881-001	CH4881	456833
5915	Broil	029-874882-001	CH4882	457932
5916	Bake	202-874883-001	CH4883	457940
5927	Bake	202-871841-002	CH610	453114
6336	Bake	202-873865-003	CH1028	453552
6337	Broil	029-873867-001	CH1030	453579
6591	Broil	029-874882-001	CH4882	457932
6592	Bake	202-874883-001	CH4883	457940
6707	Bake	202-873865-001	CH1031	453587
6822	Bake	202-874885-001	CH4885	457959
6823	Broil	029-874886-001	CH4886	457967
7141	Bake	202-874837-001	CH4887	457975
7620	Broil	029-874884-001	CH4884	456614
7621	Broil	029-874888-001	CH4888	457983
7622	Bake	202-872833-001	CH2833	456243
K-8571	Broil	029-873821-001	CH617	453122
9501	Bake	202-875818-001	CH5818	456948
9502	Bake	202-875819-001	CH5819	456956
9503	Broil	029-875816-001	CH5816	456921
9504	Broil	029-875817-001	CH5817	456930
K-11581	Broil	029-873864-001	CH1027	453544
K-12029	Broil	029-874889-001	CH4889	456841
K-14078	Broil	029-874890-001	CH4890	457810
K-15910	Broil	029-874891-001	CH4891	456850
K-116337	Bake	202-874892-001	CH4892	457828
K-116338	Bake	202-874893-001	CH4893	457836
K-16388	Bake	202-874894-001	CH4894	457852
17468	Broil	029-874861-001	CH4861	457780
17507	Mullion	417-874862-001	CH4862	457799
17692	Bake	202-874896-001	CH4896	457801
18078	Broil	029-874863-001	CH4863	456382
18079	Bake	202-874864-001	CH4864	456390
22238	Bake	202-872838-001	CH2838	456286
22238	Bake	202-875834-001	CH5834	458134
22239	Broil	029-872837-001	CH2837	456278
27374	Bake	202-873859-001	CH811	453413
27413	Bake	202-873858-001	CH810	453405
31326	Broil	029-874870-001	CH4870	456753
32890	Bake	202-873836-001	CH806	453368



Backer

Cross Reference

Bake & Broil Elements

OEM Part No.	Type	Revised Part No.	Replacement Cat. No.	PCN
--------------	------	------------------	----------------------	-----

OEM Part No.	Type	Revised Part No.	Replacement Cat. No.	PCN
--------------	------	------------------	----------------------	-----

KENMORE (continued)

33351	Bake	202-873836-001	CH807	453368
34155	Bake	202-871839-001	CH807	450589
35004	Bake	202-873836-001	CH806	453368
35499	Bake	202-871839-001	CH807	450589
37691	Bake	202-871839-001	CH807	450589
38073	Broil	029-871815-001	CH1815	453376
38078	Broil	029-871886-001	CH808	452111
38081	Bake	202-873860-001	CH628	453481
38232	Bake	202-873836-001	CH806	453368
38463	Bake	202-873837-001	CH812	453421
39127	Broil	029-871885-001	CH593	452103
39296	Broil	029-871886-001	CH808	452111
41878	Bake	202-873860-001	CH628	453481
41996	Broil	029-874866-001	CH4866	457617
41997	Bake	202-874867-001	CH4867	457756
42163	Bake	202-873860-001	CH628	453481
45596	Broil	029-871863-001	CH1003	451741
CC70781	Broil	029-875849-001	CH5849	458358
CC70845	Bake	202-875834-001	CH5834	458134
CC70855	Bake	202-875834-001	CH5834	458134
71908	Broil	029-874805-001	CH4805	457748
104711	Bake	202-871873-001	CH1012	450722
104712	Broil	029-871890-001	CH1020	453499
104787	Bake	202-873838-001	CH809	450730
106037	Bake	202-872889-001	CH2889	455953
106618	Bake	202-871874-001	CH1014	450597
106699	Bake	202-871873-007	CH813	450810
109305	Bake	202-873845-001	CH814	453430
111214	Grill	415-874819-001	CH4819	457510
113131	Broil	029-874806-001	CH4806	457625
115036	Broil	029-871890-001	CH1020	453499
115037	Bake	202-873838-001	CH809	450730
229118	Broil	029-873861-002	CH1024	453510
232184	Bake	202-874853-001	CH4853	457570
232185	Broil	029-872867-001	CH2867	455072
235297	Broil	029-873861-002	CH1024	453510
235943	Mullion	319-874809-001	CH4809	457692
237572	Bake	202-874856-001	CH4856	457668
237573	Broil	029-874814-001	CH4814	457730
238154	Bake	202-872889-001	CH2889	455953
238156	Broil	029-874821-001	CH4821	457561
239082	Broil	029-874822-001	CH4822	457764
239117	Broil	029-874806-001	CH4806	457625
239119	Bake	202-873845-001	CH814	453430
239120	Bake	202-874856-001	CH4856	457668
243946	Broil	029-871863-001	CH1003	451741
249613	Bake	202-874868-001	CH4868	456817
250545	Bake	202-874869-001	CH4869	456825
268765	Bake	202-873802-001	CH528	453026
277543	Bake	202-873857-001	CH700	453333
280507	Broil	029-874824-001	CH4824	457705
282717	Bake	202-872823-001	CH776	456091
282718	Broil	029-874845-001	CH4845	457633

KENMORE (continued)

282730	Bake	202-873862-001	CH1025	453528
282853	Broil	029-874895-001	CH4895	457713
291213	Grill	415-874820-001	CH4820	457641
293105	Broil	029-874846-001	CH4846	457537
293146	Broil	029-874847-001	CH4847	457545
293995	Broil	029-874848-001	CH4848	457772
293996	Broil	029-874849-001	CH4849	45767F
296119	Bake	202-872858-001	CH2858	454926
296121	Broil	029-872859-001	CH2859	454934
296122	Broil	029-874850-001	CH4850	457684
296565	Bake	202-872858-001	CH2858	454926
296566	Broil	029-872859-001	CH2859	454934
299043	Bake	202-874856-001	CH4856	457668
299044	Broil	029-874952-001	CH4852	457721
299427	Broil	029-874847-001	CH4847	457545
299490	Broil	029-874847-001	CH4847	457545
301444	Bake	202-872858-001	CH2858	454926
301471	Bake	202-872823-001	CH776	456091
302248	Bake	202-874853-001	CH4853	457570
302249	Bake	202-873845-001	CH814	453430
302342	Bake	202-874856-001	CH4856	457668
302449	Bake	202-874854-001	CH4854	457596
302451	Bake	202-874855-001	CH4855	457650
303295	Bake	202-875857-001	CH5857	458070
303296	Bake	202-875850-001	CH5850	458361
303801	Bake	202-874856-001	CH4856	457668
303938	Bake	202-873860-001	CH628	453481
304666	Broil	029-874858-001	CH4858	456366
304667	Bake	202-874859-001	CH4859	456374
309359	Bake	202-874825-001	CH4825	456770
309360	Broil	029-874826-001	CH4826	457860
310353	Broil	029-875824-001	CH5824	458011
311734	Bake	202-875851-001	CH5851	458505
312438	Bake	202-875852-001	CH5852	458513
316185	Broil	029-874826-001	CH4826	457860
316186	Broil	029-875824-001	CH5824	458011
319488	Broil	029-874850-001	CH4850	457684
319526	Broil	029-875826-001	CH5826	458038
319527	Broil	029-875826-001	CH5826	458038
319837	Bake	202-872823-001	CH776	456091
319842	Bake	202-873845-001	CH814	453430
319843	Bake	202-874856-001	CH4856	457668
319844	Broil	029-872882-001	CH2882	455881
319845	Broil	029-874806-001	CH4806	457625
320414	Bake	202-874855-001	CH4855	457650
320415	Bake	202-874854-001	CH4854	457596
320416	Bake	202-875850-001	CH5850	458361
320417	Bake	202-875857-001	CH5857	458070
320418	Bake	202-875851-001	CH5851	458505
320419	Bake	202-875852-001	CH5852	458513
320518	Broil	029-871890-001	CH1020	453499
320519	Broil	029-874824-001	CH4824	457705
321884	Broil	029-874830-001	CH4830	456438



Backer

Cross Reference

Bake & Broil Elements

OEM Part No.	Type	Revised Part No.	Replacement Cat. No.	PCN
--------------	------	------------------	----------------------	-----

OEM Part No.	Type	Revised Part No.	Replacement Cat. No.	PCN
--------------	------	------------------	----------------------	-----

KENMORE (continued)

321885	Bake	202-874831-001	CH4831	456446
321890	Broil	029-874858-001	CH4858	456366
321891	Bake	202-874859-001	CH4859	456374
324163	Broil	029-874826-001	CH4826	457860
324169	Broil	029-875824-001	CH5824	458011
324181	Bake	202-874825-001	CH4825	456770
324204	Bake	202-875850-001	CH5850	458361
324205	Bake	202-875857-001	CH5857	458070
324206	Bake	202-875851-001	CH5851	458505
324207	Bake	202-875852-001	CH5852	458513
324712	Bake	202-875851-001	CH5851	458505
324713	Bake	202-875852-001	CH5852	458513
325883	Bake	202-875853-001	CH5853	458521
326360	Broil	029-875855-001	CH5855	458548
326361	Broil	029-875856-001	CH5856	458556
326362	Broil	029-875855-001	CH5855	458548
326363	Broil	029-875856-001	CH5856	458556
326364	Bake	202-875854-001	CH5854	458530
326365	Bake	202-875853-001	CH5853	458521
326366	Bake	202-875854-001	CH5854	458530
326791	Bake	202-873877-001	CH687	453721
326795	Broil	029-873849-001	CH987	453472
327042	Bake	202-874854-001	CH4854	457596
327043	Bake	202-875857-001	CH5857	458070
630718	Bake	202-873863-001	CH1026	453536
630719	Bake	202-872847-001	CH2847	454424
630720	Broil	029-873839-001	CH3839	454176
630775	Broil	029-874860-001	CH4860	457588
1303562	Bake	202-872865-001	CH2865	455179
1303580	Broil	029-873841-001	CH815	453448
1303582	Broil	029-873842-001	CH821	453464
1305816	Broil	029-874870-001	CH4870	456753
1306254	Broil	029-874871-001	CH4871	457991
1307475	Bake	202-872865-001	CH2865	455179
1308772	Bake	202-874875-001	CH4875	456737
1308773	Broil	029-873866-001	CH1029	453561
1309020	Broil	029-874872-001	CH4872	457887
1310050-D	Broil	029-872891-001	CH2891	455970
1310051	Broil	029-874873-001	CH4873	457895
1310236	Broil	029-873866-001	CH1029	453561
1311292	Broil	029-874874-001	CH4874	457908
1311493	Bake	202-874875-001	CH4875	456737
1311494	Bake	202-874876-001	CH4876	456729
1311770	Broil	029-874877-001	CH4877	457916
1312852	Bake	202-874878-001	CH4878	457924
1312853	Bake	202-872892-001	CH775	455988
1312854	Bake	202-874878-001	CH4878	457924
1313169	Bake	202-874879-001	CH4879	458003
1313170	Bake	202-874880-001	CH4880	456745
1313171	Bake	202-874879-001	CH4879	458003
1313172	Bake	202-874880-001	CH4880	456745
1408-K6338	Bake	202-871846-001	CH655	453181
3212-K10739	Broil	029-873821-001	CH617	453122

LITTON

41650PO1	Bake	202-875864-001	CH5864	458601
52603PO1	Bake	202-875863-001	CH5863	458599
5260QPO1	Broil	029-875865-001	CH5865	458610

MAGIC CHEF

106A-15AM	Bake	202-872851-001	CH2851	454854
106A-25M	Bake	202-873847-001	CH637	454547
106A-35M	Bake	202-871875-001	CH596	454010
106A-35AM	Bake	202-875830-001	CH5830	458169
106A-96AM	Bake	202-875829-001	CH5829	458150
106A-153M	Bake	202-872851-001	CH2851	454854
106A-155M	Bake	202-872851-001	CH2851	454854
106A-157M	Bake	202-872817-001	CH2817	454416
106A-355M	Bake	202-873807-001	CH595	453051
106A-365M	Bake	202-872865-001	CH2865	455179
106A-385M	Bake	202-875829-001	CH5829	458150
106A-459M	Bake	202-873808-001	CH597	454029
106A-520F	Bake	202-871849-001	CH764	453341
106A-580M	Bake	202-873807-001	CH595	453051
106A-580M	Bake	202-873807-001	CH595	453051
106A-640W	Bake	202-871849-001	CH764	453341
106A-640W	Bake	202-871849-001	CH764	453341
106A-850M	Bake	202-873807-001	CH595	453051
106A-940M	Bake	202-873806-002	CH556	453739
106A-96DM	Bake	202-875829-001	CH5829	458150
106A-973M	Bake	202-872852-001	CH2852	454862
106A-976M	Bake	202-875829-001	CH5829	458150
106A-1910M	Bake	202-872822-001	CH2822	456083
106A-1960M	Bake	202-872849-001	CH2849	454969
106A-2710F	Bake	202-872854-001	CH2854	454889
106-25M	Broil	029-873884-001	CH636	454272
106-35M	Broil	029-871884-001	CH622	451709
106-35CM	Broil	029-875846-001	CH5846	458329
106-35AM	Broil	029-875846-001	CH5846	458329
106-35AM2	Broil	029-875946-001	CH5846	458329
106-96CM	Broil	029-875866-001	CH5866	458628
106-120W	Broil	029-873883-001	CH602	454248
106-153M	Broil	029-872802-001	CH708	454627
106-157M	Broil	029-872802-001	CH708	454627
106-255M	Broil	029-873884-001	CH636	454272
106-350M	Broil	029-871884-001	CH622	451709
106-352M	Broil	029-872850-001	CH2850	454977
106-355M	Broil	029-872850-001	CH2850	454977
106-358M	Broil	029-875840-001	CH5840	458265
106-385M	Broil	029-874828-001	CH4828	456411
106-580M	Broil	029-873825-003	CH638	453165
106-585M	Broil	029-874829-001	CH4829	456420
106-850M	Broil	029-873825-001	CH639	454985
106-940M	Broil	029-872861-001	CH635	454993
106-973M	Broil	029-872853-001	CH2853	454870
106-975MR	Broil	029-874827-001	CH4827	456403
106-1710F	Broil	029-871884-001	CH622	451709



Backer

Cross Reference

Bake & Broil Elements

OEM Part No.	Type	Revised Part No.	Replacement Cat. No.	PCN
--------------	------	------------------	----------------------	-----

OEM Part No.	Type	Revised Part No.	Replacement Cat. No.	PCN
--------------	------	------------------	----------------------	-----

MAGIC CHEF (continued)

106-2540M	Broil	029-871884-001	CH622	451709
106-3620M	Broil	029-873844-001	CH634	454539
1938-204	Bake	202-871849-001	CH764	453341
1938-206	Bake	202-872854-001	CH2854	454889
1938-207	Broil	029-873883-001	CH602	454248
1938-208	Broil	029-873834-001	CH603	453966
1938-209	Broil	029-871884-001	CH622	451709
1938-227	Bake	202-872822-001	CH2822	456083
1938-234	Broil	029-873844-001	CH634	454539
1938-236	Broil	029-873884-001	CH636	454272
1938-237	Bake	202-873847-001	CH637	454547
1938-242	Broil	029-871884-001	CH622	451709
1938-243	Bake	202-871875-001	CH596	454010
1938-254	Bake	202-873807-001	CH595	453051
1938-255	Broil	029-873825-001	CH639	454985
1938-258	Bake	202-872849-001	CH2849	454969
1938-260	Broil	029-872861-001	CH635	454993
1938-261	Bake	202-873806-002	CH556	453739
1938-262	Broil	029-871884-001	CH622	451709
1938-263	Broil	029-873825-003	CH638	453165
1938-264	Bake	202-873807-001	CH595	453051
1938-266	Bake	202-873808-001	CH597	454029
1938-268	Bake	202-875829-001	CH5829	458150
1938-276	Bake	202-872817-001	CH2817	454416
1938-280	Broil	029-872802-001	CH708	454627
1938-296	Bake	202-872851-001	CH2851	454854
1938-299	Broil	029-872850-001	CH2850	454977
1938-302	Broil	029-872802-001	CH708	454627
1938-312	Broil	029-872853-001	CH2853	454870
1938-313	Bake	202-872852-001	CH2852	454862
1938-320	Broil	029-874827-001	CH4827	456403
1938-321	Broil	029-872850-001	CH2850	454977
1938-323	Broil	029-874828-001	CH4828	456411
1938-324	Bake	202-875829-001	CH5829	458150
1938-325	Bake	202-875829-001	CH5829	458150
1938-326	Bake	202-872851-001	CH2851	454854
1938-328	Bake	202-873807-001	CH595	453051
1938-330	Bake	202-873807-001	CH595	453051
1938-331	Broil	029-874829-001	CH4829	456420
1938-334	Bake	202-875829-001	CH5829	458150
1938-337	Broil	029-873884-001	CH636	454272
1938-357	Bake	202-875830-001	CH5830	458169
1938-358	Broil	029-875846-001	CH5846	458329
1938-361	Broil	029-874827-001	CH4827	456403
1938-362	Bake	202-875829-001	CH5829	458150
1938-364	Bake	202-872851-001	CH2851	454854
1938-369	Broil	029-875846-001	CH5846	458329
7406P002-60	Broil	029-873884-001	CH636	454272
7406P013-60	Bake	202-875829-001	CH5829	458150
7406P032-60	Broil	029-875897-001	CH5897	440110

MARTHA WASHINGTON

-	Bake	202-870556-002	ROP-N	400477
---	------	----------------	-------	--------

MODERN MAID

74-6-5	Broil	029-873852-001	CH515G3	453018
74-6-6	Bake	202-871803-002	CH609	454045
74-6-7	Broil	029-873882-001	CH3882	454230
74-6-45	Bake	202-871700-002	ROU-N	400506
74-6-45	Bake	202-873830-001	CH587	453958
74-6-45	Bake	202-871803-001	CH620	453843
74-6-49	Broil	029-873804-001	CH554	453042
74-6-60	Broil	029-873812-001	CH583	453886
74-6-62	Bake	202-871866-001	CH1006	452200
74-6-64	Broil	029-873801-001	CH3801	454467
74-6-69	Bake	202-873830-001	CH587	453958
74-6-99	Bake	202-873803-001	CH550	453034
74-06-133	Bake	202-873854-001	CH696	453309
74-06-136	Broil	029-872880-001	CH826	455865
74-06-148	Bake	202-871853-001	CH825	453771
74-06-150	Bake	202-873854-001	CH696	453309
74-06-156	Broil	029-872881-001	CH759	455873
74-06-162	Bake	202-872821-001	CH761	456075
74-06-163	Bake	202-875828-001	CH5828	458142
74-06-164	Broil	029-873812-001	CH583	453886
74-06-166	Bake	202-871853-001	CH825	453771
74-06-171	Bake	202-872821-001	CH761	456075
74-06-172	Bake	202-875828-001	CH5828	458142
74-06-208	Bake	202-871853-001	CH825	453771
74-06-229	Bake	202-872821-001	CH761	456075
74-06-230	Bake	202-872821-001	CH761	456075

MONARCH

-	Broil	029-873878-001	CH591	453384
-	Bake	202-871883-001	CH592	453931
-	Broil	029-871845-001	CH684	453755
-	Bake	202-871855-001	CH685	453798
-	Broil	029-871891-001	CH621	451901

MONTGOMERY WARD

106-120W	Broil	029-873883-001	CH602	454248
88-5830	Bake	202-870542-001	ROP-W	400493
88-5831	Bake	202-870556-002	ROP-N	400477
88-5832	Broil	029-870167-002	RTP	400549
88-5842	Bake	202-871700-002	ROU-N	400506
88-5843	Bake	202-871702-002	ROU-W	400514
88-5846	Bake	202-871829-001	CH44X142	451629
88-5847	Bake	202-871825-002	CH44X126	450546
88-5858	Bake	202-873822-001	CH624	453131
88-5859	Bake	202-871878-001	CH625	450749



Backer

Cross Reference

Bake & Broil Elements

OEM Part No.	Type	Revised Part No.	Replacement Cat. No.	PCN
--------------	------	------------------	----------------------	-----

OEM Part No.	Type	Revised Part No.	Replacement Cat. No.	PCN
--------------	------	------------------	----------------------	-----

MONTGOMERY WARD (continued)

88-5860	Bake	202-871878-005	CH613	450757
88-5861	Bake	202-873885-001	CH44X5043	454280
88-6796	Bake	202-870968-001	ROP-T	400485
88-7930	Bake	202-872878-001	CH653W	455187
88-7932	Broil	029-870361-001	RTU	400557

PHILCO

3204-33	Bake	202-871872-001	CH1011	450861
3204-35	Broil	029-873824-001	CH632	453157
3204-40	Bake	202-871843-001	CH673	45368
3204-058-001	Broil	029-874837-001	CH4837	456518
3204-2	Bake	202-871812-001	CH656	453190

3204-8	Bake	202-871812-001	CH656	453190
--------	------	----------------	-------	--------

NATIONAL

-	Broil	029-873851-001	CH515	453000
303	Bake	202-872884-001	CH518	455902

PREWAY

K6338	Bake	202-871846-001	CH655	453181
K7677	Bake	202-871846-001	CH655	453181
K8571	Broil	029-873821-001	CH617	453122
K8893	Bake	202-871846-001	CH655	453181
K9550	Bake	202-871846-001	CH655	453181

K10739	Broil	029-873821-001	CH617	453122
K10954	Broil	029-873821-001	CH617	453122
K11581	Broil	029-873864-001	CH1027	453544
K12029	Broil	029-874889-001	CH4889	456841
K14078	Broil	029-874890-001	CH4890	457810

K14079	Bake	202-874893-001	CH4893	457836
K14242	Broil	029-874843-001	CH4843	456577
K15910	Broil	029-874891-001	CH4891	456850
K16337	Bake	202-874892-001	CH4892	457828
K16338	Bake	202-874844-001	CH4844	456593

K16338	Bake	202-874893-001	CH4893	457836
K16388	Bake	202-874894-001	CH4894	457852

NORGE

41-1647	Bake	202-872827-001	CH600	456120
41-2160	Bake	202-872827-001	CH600	456120
41-3333	Bake	202-872827-001	CH600	456120
41-4601	Broil	029-871887-001	CH601	451928
41-4677	Bake	202-871814-002	CH667	450618

41-5667	Bake	202-871814-002	CH667	450618
41-5668	Broil	029-871887-001	CH601	451928
41-5956	Bake	202-871867-001	CH956	450520
41-5958	Bake	202-871867-002	CH958	450511

NUTONE

C28077	Bake	202-871871-001	CH1010	450503
C28078	Broil	029-871889-001	CH1019	451805
D29458	Bake	202-871870-001	CH1009	450600

ROPER

31326	Broil	029-874870-001	CH4870	456753
31328	Broil	029-874870-001	CH4870	456753
71908	Broil	029-874805-001	CH4805	457748
104711	Bake	202-871873-001	CH1012	450722
104712	Broil	029-871890-001	CH1020	453499

104787	Bake	202-873838-001	CH809	450730
106037	Bake	202-872889-001	CH2889	455953
106618	Bake	202-871874-001	CH1014	450597
106699	Bake	202-871873-007	CH813	450810
109305	Bake	202-873845-001	CH814	453430

109306	Broil	029-872882-001	CH2882	455881
111214	Grill	415-874819-001	CH4819	457510
113131	Broil	029-874806-001	CH4806	457625
113965	Broil	029-876803-001	CH6803	440170
113966	Broil	029-876803-001	CH6803	440170

115036	Broil	029-871890-001	CH1020	453499
115037	Bake	202-873838-001	CH809	450730
125014	Broil	029-871890-001	CH1020	453499
229118	Broil	029-873861-002	CH1024	453510
232184	Bake	202-874853-001	CH4853	457570

O'KEEFE & MERRIT

220L003P01	Broil	029-872873-001	CH2873	455136
220L007P01	Broil	029-872871-001	CH2871	455110
221L002P01	Bake	202-871880-001	CH1016	450706
221L003P05	Bake	202-873827-005	CH709	454635
221L004P01	Bake	202-873888-001	CH710	454310

221L007P01	Bake	202-872805-001	CH712	454651
221T004P05	Bake	202-871877-001	CH626	450714

PAN PACIFIC

	Broil	029-871845-001	CH684	453755
--	-------	----------------	-------	--------

PEERLESS

P-138(2389)	Bake	202-875872-001	CH5872	458687
P-139A(2387)	Broil	029-875874-001	CH5874	458708
P-143(2394)	Bake	202-875873-001	CH5873	458695
P-144A(2383)	Broil	029-875875-001	CH5875	458716



Backer

Cross Reference Bake & Broil Elements

OEM Part No.	Type	Revised Part No.	Replacement Cat. No.	PCN
--------------	------	------------------	----------------------	-----

OEM Part No.	Type	Revised Part No.	Replacement Cat. No.	PCN
--------------	------	------------------	----------------------	-----

ROPER (continued)

232185	Broil	029-872867-001	CH2867	455072
235297	Broil	029-873861-002	CH1024	453510
235943	Mullion	417-874809-001	CH4809	457692
237571	Broil	029-876803-001	CH6803	440170
237572	Bake	202-874856-001	CH4856	457668
237573	Broil	029-874814-001	CH4814	457730
238154	Bake	202-872889-001	CH2889	455953
238156	Broil	029-874821-001	CH4821	457561
239082	Broil	029-874822-001	CH4822	457764
239117	Broil	029-874806-001	CH4806	457625
239118	Broil	029-872882-001	CH2882	455881
239119	Bake	202-873845-001	CH814	453430
239120	Bake	202-874856-001	CH4856	457668
277543	Bake	202-873857-001	CH700	453333
277543	Bake	202-874853-001	CH4853	457570
280507	Broil	029-874824-001	CH4824	457705
282717	Bake	202-872823-001	CH776	456091
282718	Broil	029-874845-001	CH4845	457633
282730	Bake	202-873872-001	CH1025	453528
282853	Broil	029-874895-001	CH4895	457713
291213	Grill	415-874820-001	CH4820	457641
293105	Broil	029-874846-001	CH4846	457537
293146	Broil	029-874847-001	CH4847	457545
293995	Broil	029-874848-001	CH4848	457772
293996	Broil	029-874849-001	CH4849	457676
296119	Bake	202-872858-001	CH2858	454926
296121	Broil	029-872859-001	CH2859	454934
296122	Broil	029-874850-001	CH4850	457684
296565	Bake	202-872858-001	CH2858	454926
296566	Broil	029-872859-001	CH2859	454934
299043	Bake	202-874856-001	CH4856	457668
299044	Broil	029-874852-001	CH4852	457721
299427	Broil	029-874847-001	CH4847	457545
299490	Broil	029-874847-001	CH4847	457545
301444	Bake	202-872858-001	CH2858	454926
301471	Bake	202-872823-001	CH776	456091
302248	Bake	202-874853-001	CH4853	457570
302249	Bake	202-873845-001	CH814	453430
302342	Bake	202-874856-001	CH4856	457668
302449	Bake	202-874854-001	CH4854	457596
302451	Bake	202-874855-001	CH4855	457650
303296	Bake	202-875850-001	CH5850	458361
303615	Broil	029-874830-001	CH4830	456438
303616	Bake	202-874831-001	CH4831	456446
303801	Bake	202-874856-001	CH4856	457668
303938	Bake	202-873860-001	CH628	453481
304666	Broil	029-874858-001	CH4858	456366
304667	Bake	202-874859-001	CH4859	456374
304997	Bake	202-874854-001	CH4854	457596
309359	Bake	202-874825-001	CH4825	456770
309360	Broil	029-874826-001	CH4826	457860
310353	Broil	029-875824-001	CH5824	458011
310604	Grill	415-874817-001	CH4817	456454

ROPER (continued)

311734	Bake	202-875851-001	CH5851	458505
312438	Bake	202-875851-001	CH5851	458505
314620	Bake	202-872823-001	CH776	456091
316185	Broil	029-874826-001	CH4826	457860
316186	Broil	029-875824-001	CH5824	458011
319487	Broil	029-872859-001	CH2859	454934
319488	Broil	029-874850-001	CH4850	457684
319526	Broil	029-875826-001	CH5826	458038
319527	Broil	029-875826-001	CH5826	458038
319529	Bake	202-872823-001	CH776	456091
319837	Bake	202-872823-001	CH776	456091
319838	Bake	202-872823-001	CH776	456091
319842	Bake	202-873845-001	CH814	453430
319843	Bake	202-874856-001	CH4856	457668
319844	Broil	029-872882-001	CH2882	455881
319845	Broil	029-874806-001	CH4806	457625
320414	Bake	202-874855-001	CH4855	457650
320415	Bake	202-874854-001	CH4854	457596
320416	Bake	202-874850-001	CH4850	458361
320418	Bake	202-875851-001	CH5851	458505
320419	Bake	202-875851-001	CH5851	458505
320420	Bake	202-872823-001	CH776	456091
320421	Bake	202-872823-001	CH776	456091
320518	Broil	029-871890-001	CH1020	453499
320519	Broil	029-874824-001	CH4824	457705
321667	Bake	202-872858-001	CH2858	454926
321884	Broil	029-874830-001	CH4830	456438
321885	Bake	202-874831-001	CH4831	456446
321890	Broil	029-874858-001	CH4858	456366
321891	Bake	202-874859-001	CH4859	456374
322635	Grill	415-874818-001	CH4818	458062
324163	Broil	029-872859-001	CH2859	454934
324168	Broil	029-874826-001	CH4826	457860
324169	Broil	029-875824-001	CH5824	458011
324177	Broil	029-871890-001	CH1020	453499
324178	Broil	029-871890-001	CH1020	453499
324181	Bake	202-874825-001	CH4825	456770
324186	Bake	202-872823-001	CH776	456091
324187	Bake	202-872823-001	CH776	456091
324204	Bake	202-875850-001	CH5850	458361
324206	Bake	202-875851-001	CH5851	458505
324207	Bake	202-875851-001	CH5851	458505
324249	Broil	029-872859-001	CH2859	454934
324251	Broil	029-872859-001	CH2859	454934
324712	Bake	202-875851-001	CH5851	458505
324713	Bake	202-875851-001	CH5851	458505
325883	Bake	202-875853-001	CH5853	458521
326360	Broil	029-875855-001	CH5855	458548
326361	Broil	029-875856-001	CH5856	458556
326362	Broil	029-875855-001	CH5855	458548
326363	Broil	029-875856-001	CH5856	458556
326364	Bake	202-875853-001	CH5853	458521
326365	Bake	202-875853-001	CH5853	458521



Backer

Cross Reference

Bake & Broil Elements

OEM Part No.	Type	Revised Part No.	Replacement Cat. No.	PCN
--------------	------	------------------	----------------------	-----

ROPER (continued)

326366	Bake	202-875853-001	CH5853	458521
326791	Bake	202-873877-001	CH687	453721
326795	Broil	029-873849-001	CH987	453472
326938	Broil	029-875855-001	CH5855	458548
326939	Broil	029-875855-001	CH5855	458548
331164	Bake	202-875851-001	CH5851	458505
332563	Bake	202-875851-001	CH5851	458505
334368	Broil	029-875899-001	CH5899	440137
334369	Broil	029-875899-001	CH5899	440137
335912	Bake	202-875894-001	CH5894	440081
335913	Bake	202-875894-001	CH5894	440081
630718	Bake	202-873863-001	CH1026	453536
630719	Bake	202-872847-001	CH2847	454424
630720	Broil	029-873839-001	CH3839	454176
630775	Broil	029-874860-001	CH4860	457588

STILLMAN

TS515	Broil	-	CH515	453000
TS515G3	Broil	-	CH515G3	453018
TS518	Bake	-	CH518	455902
TS527	Broil	-	CH527	454184
TS528	Bake	-	CH528	453026
TS550	Bake	-	CH550	453034
TS551	Bake	-	ROU-N	400506
TS552	Bake	-	CH44X5021	454205
TS554	Broil	-	CH554	453042
TS555	Bake	-	CH555	456104
TS556	Bake	-	CH556	453739
TS557	Bake	-	CH557	453860
TS558	Bake	-	CH558	454213
TS559	Bake	-	CH559	453878
TS560	Bake	-	CH595	453051
TS562	Broil	-	CH562	453069
TS563	Bake	-	CH563	453077
TS564	Bake	-	CH564	453085
TS565	Bake	-	ROP-N	400477
TS571	Bake	-	CH44X163	451637
TS572	Bake	-	CH45X5008	450562
TS573	Bake	-	ROA-N	400400
TS574	Bake	-	ROA-W	400418
TS575	Broil	-	RTA	400522
TS576	Broil	-	RTP	400549
TS577	Bake	-	ROP-N	400477
TS579	Broil	-	RTU	400557
TS580	Bake	-	ROU-N	400506
TS582	Bake	-	ROU-W	400514
TS583	Broil	-	CH583	453886
TS584	Bake	-	CH584	453093
TS585	Broil	-	CH585	453894
TS586	Bake	-	CH586	453907
TS587	Bake	-	CH587	453958
TS588	Bake	-	CH588	453915

OEM Part No.	Type	Revised Part No.	Replacement Cat. No.	PCN
--------------	------	------------------	----------------------	-----

STILLMAN (continued)

TS591	Broil	-	CH591	453384
TS592	Bake	-	CH592	453931
TS593	Broil	-	CH593	452103
TS594	Bake	-	CH594	454002
TS595	Bake	-	CH595	453051
TS596	Bake	-	CH596	454010
TS597	Bake	-	CH597	454029
TS598	Broil	-	CH1019	451805
TS601	Broil	-	CH601	451928
TS602	Broil	-	CH602	454248
TS606	Bake	-	CH2854	454889
TS607	Bake	-	CH590	454221
TS608	Bake	-	CH608	454256
TS609	Bake	-	CH609	454045
TS610	Bake	-	CH610	453114
TS611	Bake	-	CH611	450976
TS612	Broil	-	CH612	451821
TS613	Bake	-	CH613	450757
TS616	Bake	-	CH613	450757
TS617	Broil	-	CH617	453122
TS618	Bake	-	CH625	450749
TS619	Broil	-	CH619	451725
TS620	Bake	-	CH620	453843
TS621	Broil	-	CH621	451901
TS622	Broil	-	CH622	451709
TS624	Bake	-	CH624	453131
TS625	Bake	-	CH625	450749
TS626	Bake	-	CH626	450714
TS627	Bake	-	CH627	454264
TS628	Bake	-	CH628	453481
TS629	Bake	-	CH629	453149
TS631	Bake	-	CH624	453131
TS632	Broil	-	CH632	453157
TS633	Bake	-	CH633	454053
TS635	Broil	-	CH635	454993
TS636	Broil	-	CH636	454272
TS637	Bake	-	CH637	454547
TS638	Broil	-	CH638	453165
TS639	Broil	-	CH639	454985
TS640	Bake	-	CH640	454061
TS641	Bake	-	CH641	453237
TS642	Broil	-	CH642	453392
TS643	Bake	-	CH643	454070
TS644	Bake	-	CH644	454520
TS645	Bake	-	CH645	455021
TS646	Broil	-	CH646	453501
TS648	Bake	-	CH648	451514
TS649	Bake	-	CH649	451506
TS650	Bake	-	CH650	451303
TS651	Bake	-	CH651	451400



Backer

Cross Reference

Bake & Broil Elements

OEM Part No.	Type	Revised Part No.	Replacement Cat. No.	PCN
--------------	------	------------------	----------------------	-----

OEM Part No.	Type	Revised Part No.	Replacement Cat. No.	PCN
--------------	------	------------------	----------------------	-----

STILLMAN (continued)

TS652	Bake	-	CH652	451311
TS653	Bake	-	CH653	451418
TS654	Bake	-	CH654	451004
TS655	Bake	-	CH655	453181
TS655W	Bake	-	CH655W	450950
TS656	Bake	-	CH656	453190
TS656W	Bake	-	CH656W	450968
TS657	Bake	-	CH657	451223
TS658	Broil	-	CH658	451733
TS659	Broil	-	CH659	453923
TS660	Bake	-	CH660	453202
TS661	Bake	-	CH661	453211
TS662	Bake	-	CH662	453229
TS663	Bake	-	CH625	450749
TS664	Bake	-	CH664	453245
TS665	Bake	-	CH665	453253
TS670	Broil	-	CH670	453261
TS671	Broil	-	CH671	453270
TS672	Bake	-	CH672	455857
TS673	Bake	-	CH673	453683
TS674	Broil	-	CH3887	454301
TS675	Bake	-	CH675	454432
TS676	Broil	-	CH676	453747
TS677	Broil	-	CH677	454555
TS678	Bake	-	CH678	455005
TS679	Bake	-	CH679	453819
TS680	Bake	-	CH680	453827
TS681	Broil	-	CH681	454563
TS682	Broil	-	CH682	454571
TS684	Broil	-	CH684	453755
TS685	Bake	-	CH685	453798
TS686	Bake	-	CH685	453798
TS687	Bake	-	CH687	453721
TS688	Broil	-	CH3801	454467
TS689	Bake	-	CH1006	452200
TS690	Broil	-	CH671	453270
TS691	Bake	-	CH691	453288
TS693	Bake	-	CH693	453296
TS694	Bake	-	CH694	453801
TS696	Bake	-	CH696	453309
TS697	Bake	-	CH697	454803
TS698	Bake	-	CH698	453317
TS699	Broil	-	CH699	453325
TS700	Bake	-	CH700	453333
TS701	Bake	-	CH1004	450870
TS702	Bake	-	ROU-T	403037
TS705	Bake	-	CH705	454619
TS706	Broil	-	CH3887	454301
TS707	Bake	-	CH707	453763
TS708	Broil	-	CH708	454627
TS709	Bake	-	CH709	454635
TS712	Bake	-	CH712	454651
TS713	Bake	-	CH713	454660

STILLMAN (continued)

TS714	Bake	-	CH714	456040
TS715	Bake	-	CH679	453819
TS716	Bake	-	CH2864	455152
TS717	Bake	-	CH2865	455179
TS718	Bake	-	CH2866	455080
TS720	Broil	-	CH2867	455072
TS722	Broil	-	CH2899	456059
TS724	Broil	-	CH2869	455099
TS727	Bake	-	CH2860	454820
TS728	Broil	-	CH2871	455110
TS729	Broil	-	CH1030	453579
TS730	Bake	-	CH2844	453851
TS731	Bake	-	CH2872	455123
TS733	Broil	-	CH591	453384
TS734	Bake	-	CH1001	450790
TS736	Broil	-	CH1003	451741
TS737	Broil	-	CH1027	453544
TS738	Bake	-	CH1040	453675
TS739	Bake	-	CH1005	450802
TS740	Broil	-	CH1039	453667
TS741	Broil	-	CH1006	452200
TS743	Bake	-	CH1011	450861
TS744	Bake	-	CH1012	450722
TS745	Bake	-	CH1031	453587
TS746	Broil	-	CH1020	453499
TS747	Bake	-	CH1025	453528
TS748	Bake	-	CH1026	453536
TS749	Bake	-	CH1016	450706
TS750	Broil	-	CH1042	453691
TS751	Broil	-	CH1044	453712
TS752	Bake	-	CH2857	454918
TS753	Broil	-	CH1036	453632
TS755	Broil	-	CH1029	453561
TS757	Bake	-	CH1014	450597
TS758	Bake	-	CH1028	453552
TS759	Broil	-	CH759	455873
TS760	Broil	-	CH3839	454176
TS761	Bake	-	CH761	456075
TS762	Broil	-	CH1024	453510
TS763	Broil	-	CH2850	454977
TS764	Bake	-	CH764	453341
TS765	Bake	-	CH2822	456083
TS767	Bake	-	CH1010	450503
TS768	Bake	-	CH1015	450765
TS769	Broil	-	CH1019	451805
TS771	Bake	-	CH1035	453624
TS772	Broil	-	CH1043	453704
TS773	Bake	-	CH3800	454440
TS774	Broil	-	CH2891	455970
TS775	Bake	-	CH775	455988
TS776	Bake	-	CH776	456091
TS777	Bake	-	CH2858	454926



Backer

Cross Reference

Bake & Broil Elements

OEM Part No.	Type	Revised Part No.	Replacement Cat. No.	PCN
--------------	------	------------------	----------------------	-----

OEM Part No.	Type	Revised Part No.	Replacement Cat. No.	PCN
--------------	------	------------------	----------------------	-----

STILLMAN (continued)

TS778	Bake	-	CH687	453721
TS779	Broil	-	CH779	455996
TS780	Bake	-	CH780	456008
TS781	Bake	-	CH781	456016
TS782	Bake	-	CH1858	453835
TS783	Bake	-	CH783	456622
TS785	Bake	-	CH596	454010
TS786	Bake	-	CH2833	456243
TS787	Broil	-	CH4884	456614
TS788	Broil	-	CH2882	455881
TS789	Broil	-	CH2859	454934
TS790	Bake	-	CH4836	456500
TS791	Bake	-	CH5870	458660
TS792	Bake	-	CH4825	456770
TS793	Broil	-	CH4826	457860
TS794	Broil	-	CH4839	456534
TS795	Bake	-	CH5828	458142
TS796	Broil	-	CH5835	458214
TS797	Broil	-	CH5837	458230
TS798	Bake	-	CH5830	458169
TS799	Bake	-	CH2851	454854
TS802	Bake	-	CH802	456147
TS805	Bake	-	CH805	453350
TS807	Bake	-	CH807	450589
TS808	Broil	-	CH808	452111
TS809	Bake	-	CH809	450730
TS811	Bake	-	CH811	453413
TS812	Bake	-	CH812	453421
TS813	Bake	-	CH813	450810
TS814	Bake	-	CH814	453430
TS815	Broil	-	CH815	453448
TS816	Broil	-	CH816	453595
TS818	Bake	-	CH818	453456
TS823	Broil	-	CH4843	456577
TS824	Broil	-	CH824	454790
TS825	Bake	-	CH825	453771
TS826	Broil	-	CH826	455865
TS828	Bake	-	CH4825	456770
TS829	Broil	-	CH4874	457908
TS830	Broil	-	CH4821	457561
TS831	Broil	-	CH4826	457860
TS832	Bake	-	CH4896	457801
TS833	Broil	-	CH4845	457633
TS834	Bake	-	CH4880	456745
TS835	Broil	-	CH4847	457545
TS836	Bake	-	CH4853	457570
TS837	Bake	-	CH4879	458003
TS838	Bake	-	CH4854	457596
TS839	Bake	-	CH4893	457836
TS840	Bake	-	CH4892	457828
TS841	Bake	-	CH2860	454820
TS842	Bake	-	CH5818	456948
TS843	Broil	-	CH5816	456921

STILLMAN (continued)

TS844	Broil	-	CH5814	456905
TS845	Bake	-	CH5823	456999
TS846	Broil	-	CH5813	456892
TS847	Broil	-	CH5810	456868
TS848	Bake	-	CH4875	456737
TS849	Broil	-	CH4822	457764
TS850	Bake	-	CH4856	457668
TS851	Broil	-	CH4826	457860
TS853	Bake	-	CH679	453819
TS854	Broil	-	CH5846	458329
TS855	Bake	-	CH4833	456470
TS856	Bake	-	CH5829	458150
TS857	Bake	-	CH5853	458521
TS858	Broil	-	CH5855	458548
TS860	Broil	-	CH4830	456438
TS956	Bake	-	CH956	450520
TS958	Bake	-	CH958	450511
TS959	Bake	-	CH959	456155
TS960	Bake	-	CH960	454344
TS961	Bake	-	CH961	454352
TS962	Broil	-	CH962	454694
TS963	Bake	-	CH963	454360
TS964	Bake	-	CH964	454379
TS965	Bake	-	CH965	454387
TS966	Bake	-	CH966	454109
TS967	Bake	-	CH967	454117
TS968	Bake	-	CH968	451207
TS969	Bake	-	CH969	454125
TS970	Broil	-	CH970	454133
TS971	Broil	-	CH971	454141
TS974	Broil	-	CH974	454715
TS975	Bake	-	CH975	451127
TS976	Broil	-	CH976	454723
TS977	Broil	-	CH977	454731
TS978	Bake	-	CH978	454150
TS979	Bake	-	CH979	454168
TS980	Bake	-	CH44X5019	451119
TS981	Bake	-	CH44X5043	454280
TS982	Bake	-	CH44X142	451629
TS983	Broil	-	CH44X5006	454774
TS985	Broil	-	CH44X5045	453780
TS986	Broil	-	CH45X5020	454838
TS987	Broil	-	CH987	453472
TS1001	Bake	-	CH1001	450790
TS1003	Broil	-	CH1003	451741
TS1004	Bake	-	CH1004	450870
TS1005	Bake	-	CH1005	450802
TS1006	Bake	-	CH1006	452200
TS1010	Bake	-	CH1010	450861
TS1012	Bake	-	CH1012	450722
TS1016	Bake	-	CH1016	450706
TS1020	Broil	-	CH1020	453499



Backer

Cross Reference

Bake & Broil Elements

OEM Part No.	Type	Revised Part No.	Replacement Cat. No.	PCN
--------------	------	------------------	----------------------	-----

OEM Part No.	Type	Revised Part No.	Replacement Cat. No.	PCN
--------------	------	------------------	----------------------	-----

STILLMAN (continued)

TS1025	Bake	-	CH1025	453528
TS1026	Bake	-	CH1026	453536
TS1027	Broil	-	CH1027	453544
TS1028	Bake	-	CH1028	453552
TS1029	Broil	-	CH1029	453561
TS1030	Broil	-	CH1030	453579
TS1031	Bake	-	CH1031	453587
TS1035	Bake	-	CH1035	453624
TS1036	Broil	-	CH1036	453632
TS1039	Broil	-	CH1039	453667
TS1040	Bake	-	CH1040	453675
TS1042	Broil	-	CH1042	453691
TS1815	Broil	-	CH1815	453376
TS1858	Bake	-	CH1858	453835
TS2822	Bake	-	CH2822	456083
TS2833	Bake	-	CH2833	456243
TS2835	Bake	-	CH2835	456251
TS2837	Broil	-	CH2837	456278
TS2838	Bake	-	CH2838	456286
TS2839	Broil	-	CH2839	456294
TS2846	Bake	-	CH2846	456340
TS2848	Bake	-	CH2848	454459
TS2849	Bake	-	CH2849	454969
TS2850	Broil	-	CH2850	454977
TS2852	Bake	-	CH2852	454862
TS2853	Broil	-	CH2853	454870
TS2858	Bake	-	CH2858	454926
TS2859	Broil	-	CH2859	454934
TS2860	Bake	-	CH2860	454820
TS2864	Bake	-	CH2864	455152
TS2865	Bake	-	CH2865	455179
TS2866	Bake	-	CH2866	455080
TS2867	Broil	-	CH2867	455072
TS2876	Bake	-	CH2876	455160
TS2882	Broil	-	CH2882	455881
TS2889	Bake	-	CH2889	455953
TS2891	Broil	-	CH2891	455970
TS2899	Broil	-	CH2899	456059
TS3800	Bake	-	CH3800	454440
TS3839	Broil	-	CH3839	454176
TS3882	Broil	-	CH3882	454230
TS4806	Broil	-	CH4806	457625
TS4809	Mullion	-	CH4809	457692
TS4818	Grill	-	CH4818	458062
TS4819	Grill	-	CH4819	457510
TS4820	Grill	-	CH4820	457641
TS4821	Broil	-	CH4821	457561
TS4822	Broil	-	CH4822	457764
TS4824	Broil	-	CH4824	457705
TS4825	Bake	-	CH4825	456770
TS4826	Broil	-	CH4826	457860
TS4827	Broil	-	CH4827	456403
TS4829	Broil	-	CH4829	456420

STILLMAN (continued)

TS4830	Broil	-	CH4830	456438
TS4831	Bake	-	CH4831	456446
TS4832	Bake	-	CH4832	456462
TS4833	Bake	-	CH4833	456470
TS4835	Broil	-	CH4835	456497
TS4836	Bake	-	CH4836	456500
TS4838	Bake	-	CH4838	456526
TS4839	Broil	-	CH4839	456534
TS4845	Broil	-	CH4845	457633
TS4847	Broil	-	CH4847	457545
TS4853	Bake	-	CH4853	457570
TS4854	Bake	-	CH4854	457596
TS4855	Bake	-	CH4855	457650
TS4866	Broil	-	CH4866	457617
TS4867	Bake	-	CH4867	457756
TS4868	Bake	-	CH4868	456817
TS4869	Bake	-	CH4869	456825
TS4870	Broil	-	CH4870	456743
TS4871	Broil	-	CH4871	457991
TS4874	Bake	-	CH4874	457908
TS4876	Bake	-	CH4876	456729
TS4879	Bake	-	CH4879	458003
TS4880	Bake	-	CH4880	456745
TS4881	Bake	-	CH4881	456833
TS4884	Broil	-	CH4884	456614
TS4890	Broil	-	CH4890	457810
TS4892	Bake	-	CH4892	457828
TS4893	Bake	-	CH4893	457836
TS4895	Broil	-	CH4895	457713
TS4896	Bake	-	CH4896	457801
TS5810	Broil	-	CH5810	456868
TS5811	Bake	-	CH5811	456876
TS5813	Broil	-	CH5813	456892
TS5814	Broil	-	CH5814	456905
TS5815	Bake	-	CH5815	456913
TS5816	Broil	-	CH5816	456921
TS5818	Bake	-	CH5818	456948
TS5820	Bake	-	CH5820	456964
TS5823	Bake	-	CH5823	456999
TS5827	Broil	-	CH5827	458046
TS5828	Bake	-	CH5828	458142
TS5829	Bake	-	CH5829	458150
TS5830	Bake	-	CH5830	458169
TS5834	Bake	-	CH5834	458134
TS5836	Broil	-	CH5836	458222
TS5837	Broil	-	CH5837	458230
TS5840	Broil	-	CH5840	458265
TS5841	Bake	-	CH5841	458273
TS5842	Bake	-	CH5842	458281
TS5846	Broil	-	CH5846	458329
TS5848	Bake	-	CH5848	458345
TS5849	Broil	-	CH5849	458358
TS5853	Bake	-	CH5853	458521



Backer

Cross Reference

Bake & Broil Elements

OEM Part No.	Type	Revised Part No.	Replacement Cat. No.	PCN
--------------	------	------------------	----------------------	-----

OEM Part No.	Type	Revised Part No.	Replacement Cat. No.	PCN
--------------	------	------------------	----------------------	-----

STILLMAN (continued)

TS5854	Bake	-	CH5853	458521
TS5855	Broil	-	CH5855	458548
TS5856	Broil	-	CH5855	458548
TS5860	Bake	-	CH5860	458564
TS5862	Bake	-	CH5862	458580
TS5863	Bake	-	CH5863	458599
TS5864	Bake	-	CH5864	458601
TS5865	Broil	-	CH5865	458610
TS5868	Bake	-	CH5868	458644
TS5869	Broil	-	CH5869	458652
TS5870	Bake	-	CH5870	458660
TS5888	Broil	-	CH5888	440022
TS5890	Broil	-	CH5890	440049
TS5891	Bake	-	CH5891	440057
TS5893	Bake	-	CH5893	440073
TS5894	Bake	-	CH5894	440081
TS5896	Broil	-	CH5896	440102
TS5897	Broil	-	CH5897	440110
TS5898	Broil	-	CH5898	440129
TS6800	Bake	-	CH6800	440145
TS6801	Broil	-	CH6801	440153
TS7101	Bake	-	CH4836	456500
TS7102	Broil	-	CH5888	440022
TS7103	Broil	-	CH5888	440022
TS7104	Bake	-	CH5830	458169
TS7108	Broil	-	CH5898	440129
TS7112	Bake	-	CH5841	458273
TS7113	Broil	-	CH1019	451805
TS7115	Broil	-	CH2859	454934
TS7125	Broil	-	CH5836	458222
TS7126	Broil	-	CH5816	456921
TS7129	Bake	-	CH5829	458150
TS44X126	Bake	-	CH44X126	450546
TS44X127	Bake	-	CH44X196	458310
TS44X134	Broil	-	CH44X134	454096
TS44X136	Broil	-	CH44X136	454512
TS44X142	Bake	-	CH44X142	451629
TS44X160	Bake	-	CH44X200	458290
TS44X164	Bake	-	CH44X164	453173
TS44X165	Bake	-	CH44X165	454740
TS44X169	Bake	-	CH44X169	454766
TS44X170	Bake	-	CH44X170	454491
TS44X173	Broil	-	CH44X185	458302
TS44X185	Broil	-	CH44X185	458302
TS44X196	Bake	-	CH44X196	458310
TS44X200	Bake	-	CH44X200	458290
TS44X5043	Bake	-	CH44X5043	454280
TS44X5074	Broil	-	CH44X5074	458185
TS44X5082	Bake	-	CH44X5082	458193
TS44X5083	Bake	-	CH44X5083	458206
TS44X5099	Bake	-	CH44X5099	454811
TS45X56	Bake	-	CH45X56	452007
TS45X58	Bake	-	CH44X142	451629

SUBURBAN

R23220	Bake	202-871803-001	CH620	453843
R23221	Broil	029-871891-001	CH621	451901

SUNRAY

03000	Bake	202-871876-001	CH1015	450765
03000-04	Bake	202-871876-001	CH1015	450765
03001	Bake	202-874833-001	CH4833	456470
03001-04	Bake	202-874833-001	CH4833	456470
03002	Bake	202-874832-001	CH4832	456462
03002-04	Bake	202-874832-001	CH4832	456462
03005	Broil	029-871891-001	CH621	451901
03005-04	Broil	029-874835-001	CH4835	456497
07398	Bake	202-871840-001	CH1840	454408
07398-04	Bake	202-871840-001	CH1840	454408
07399	Broil	029-873879-001	CH527	454184
07399-04	Broil	029-873879-001	CH527	454184
7498-004	Bake	202-871840-001	CH1840	454408
74096-00	Bake	202-874833-001	CH4833	456470
74098-01	Bake	202-874832-001	CH4832	456462
74098-02	Bake	202-971876-001	CH1015	450765
74102-00	Bake	202-871840-001	CH1840	454408
74311-00	Broil	029-874835-001	CH4835	456497
-	Bake	202-873893-001	CH683	454580

TAPPAN

01-233-1	Bake	202-871802-001	CH616	450773
01-233-2	Broil	029-871892-001	CH619	451725
01-233-2	Broil	029-871892-001	CH619	451725
01-233-3	Bake	202-871802-001	CH616	450773
03-233-9	Broil	029-871892-003	CH1044	453712
400-233-2	Bake	202-871878-001	CH625	450749
400-233-3	Broil	029-871859-001	CH612	451821
85-233-21	Bake	202-871879-001	CH654	451004
220L003P01	Broil	029-872873-001	CH2873	455136
220L007P01	Broil	029-872871-001	CH2871	455110
220T001P01	Broil	029-871859-001	CH612	451821
220T007P01	Broil	029-873833-001	CH671	453270
220T008P01	Broil	029-873832-001	CH670	453261
220T008P02	Broil	029-873832-002	CH1042	453691
220T008P05	Broil	029-873832-001	CH670	453261
220T009P01	Broil	029-872886-001	CH2886	455929
220T010P01	Broil	029-873833-001	CH671	453270
220T010P04	Broil	029-873833-001	CH671	453270
220T011P01	Broil	029-873876-001	CH1043	453704
220T012P01	Broil	029-872863-001	CH2863	456200
220T012P03	Broil	029-872863-001	CH2863	456200
220T012P05	Broil	029-872863-001	CH2863	456200
220T017P01	Broil	029-873833-001	CH671	453270
220T017P02	Broil	029-872863-001	CH2863	456200
221L003P01	Bake	202-873827-001	CH660	453202



Backer

Cross Reference

Bake & Broil Elements

OEM Part No.	Type	Revised Part No.	Replacement Cat. No.	PCN
--------------	------	------------------	----------------------	-----

OEM Part No.	Type	Revised Part No.	Replacement Cat. No.	PCN
--------------	------	------------------	----------------------	-----

TAPPAN (continued)

221L003P03	Bake	202-873827-001	CH660	453202
221L003P05	Bake	202-873827-005	CH709	454635
221L004P01	Bake	202-873888-001	CH710	454310
221L006P01	Bake	202-873853-001	CH693	453296
221L007P01	Bake	202-872805-001	CH712	454651
221S001P01	Bake	202-875895-001	CH5895	440090
221T004P01	Bake	202-871878-001	CH625	450749
221T004P03	Bake	202-871878-001	CH625	450749
221T004P05	Bake	202-871877-001	CH626	450714
221T004P07	Bake	202-871878-003	CH691	453288
221T004P09	Bake	202-871878-005	CH613	450757
221T004P11	Bake	202-871879-001	CH654	451004
221T004P13	Bake	202-871879-001	CH654	451004
221T008P01	Bake	202-873822-001	CH624	453131
221T008P03	Bake	202-873822-001	CH624	453131
221T009P01	Bake	202-873828-001	CH661	453211
221T010P01	Bake	202-873831-001	CH664	453245
221T010P02	Bake	202-873831-002	CH665	453253
221T010P04	Bake	202-873831-001	CH664	453245
221T011P01	Bake	202-873829-001	CH662	453229
221T011P02	Bake	202-873813-002	CH584	453093
221T011P06	Bake	202-875847-001	CH5847	458337
221T011P07	Bake	202-873813-002	CH584	453093
221T011P08	Bake	202-875847-001	CH5847	458337
221T011P10	Bake	202-873813-002	CH584	453093
221T011P11	Bake	202-875847-001	CH5847	458337
221T014P01	Bake	202-872874-001	CH2874	455144
221T014P03	Bake	202-872872-001	CH2872	455123
221T014P05	Bake	202-872874-001	CH2874	455144
221T014P06	Bake	202-872872-001	CH2872	455123
221T014P08	Bake	202-872874-001	CH2874	455144
221T014P09	Bake	202-872872-001	CH2872	455123
221T014P12	Bake	202-872872-001	CH2872	455123
221T014P13	Bake	202-872872-001	CH2872	455123
221T015P01	Bake	202-872866-001	CH2866	455080
221T015P03	Bake	202-872866-001	CH2866	455080
221T015P05	Bake	202-872866-001	CH2866	455080
221T017P01	Bake	202-873813-002	CH584	453093
221T018P01	Bake	202-875847-001	CH5847	458337
221T019P01	Bake	202-875848-001	CH5848	458345
221T020P01	Bake	202-875867-001	CH5867	458636
221T021P01	Bake	202-872866-001	CH2866	455080
221T023P01	Bake	202-875895-001	CH5895	440090
221T023P03	Bake	202-875895-001	CH5895	440090

THERMADOR

14-09-466A	Bake	202-872829-001	CH802	456147
14-09-526	Bake	202-872820-001	CH2820	456067
14-09-639	Bake	202-872829-001	CH802	456147
14-29-553	Bake	202-875841-001	CH5841	458273
14-29-554	Bake	202-875842-001	CH5841	458273

THERMADOR (continued)

14-29-555	Bake	202-875842-001	CH5842	458281
14-29-556	Bake	202-875842-001	CH5842	458134
14-29-726	Bake	202-875842-001	CH5842	458134
14-29-728	Bake	202-875842-001	CH5842	458281
14-29-765	Bake	202-875842-001	CH5842	458281
14-29-766	Bake	202-875842-001	CH5842	458134
-	Bake	202-872824-001	CH555	456104
-	Broil	029-872875-001	CH957	456180
-	Bake	202-871701-001	ROU-T	403037
-	Bake	202-871701-001	ROU-T	403037
14-39-311	Bake	202-875842-001	CH5842	458134
14-39-312	Bake	202-875842-001	CH5842	458134
14-39-313	Broil	029-875898-001	CH5898	440129
14-39-314	Broil	029-875898-001	CH5898	440129

WASTE KING

728184	Broil	029-871885-001	CH593	452103
100271	Bake	202-873816-001	CH594	454002
-	Bake	202-871861-001	CH557	453860
-	Bake	202-871861-002	CH558	454213
-	Bake	202-871861-003	CH559	453878
-	Bake	202-872825-001	CH803	456112

WEDGEWOOD

-	Bake	202-871899-001	CH590	454221
---	------	----------------	-------	--------

WELBILT

9-36	Bake	202-871861-002	CH558	454213
9-42	Bake	202-871861-001	CH557	453860
9-52	Bake	202-871861-003	CH559	453878
-	Bake	202-872825-001	CH803	456112

WESTINGHOUSE

Q1761	Bake	202-871807-001	CH650	451303
Q1762	Bake	202-871807-001	CH650	451303
Q1763	Bake	202-871807-001	CH650	451303
Q1764	Bake	202-871807-001	CH650	451303
Q1784	Bake	202-871809-001	CH652	451311
Q1785	Bake	202-871809-001	CH652	451311
Q1791	Bake	202-871807-001	CH650	451303
Q1792	Bake	202-871807-001	CH650	451303
Q13931	Bake	202-871882-001	CH643	454070
Q13932	Bake	202-871882-001	CH643	454070
Q13933	Bake	202-871882-001	CH643	454070
Q13934	Bake	202-871882-001	CH643	454070
Q13935	Bake	202-871882-001	CH643	454070
Q13939	Bake	202-871882-001	CH643	454070
Q13940	Bake	202-871882-001	CH643	454070



Backer

Cross Reference

Bake & Broil Elements

OEM Part No.	Type	Revised Part No.	Replacement Cat. No.	PCN
--------------	------	------------------	----------------------	-----

OEM Part No.	Type	Revised Part No.	Replacement Cat. No.	PCN
--------------	------	------------------	----------------------	-----

WESTINGHOUSE (continued)

Q13951	Broil	029-873890-001	CH677	454555
Q13953	Broil	029-873890-001	CH677	454555
Q25971	Broil	029-871842-001	CH646	453501
Q25976	Broil	029-872868-001	CH2868	456198
Q25979	Broil	029-872868-001	CH2868	456198
Q25981	Broil	029-871842-001	CH646	453501
Q25986	Broil	029-871842-001	CH646	453501
Q25999	Broil	029-871842-001	CH646	453501
Q26001	Broil	029-872868-001	CH2868	456198
Q26002	Broil	029-872868-001	CH2868	456198
Q26003	Broil	029-871842-001	CH646	453501
Q26005	Broil	029-871842-001	CH646	453501
Q26009	Broil	029-871842-001	CH646	453501
Q26010	Broil	029-871842-001	CH646	453501
Q26011	Broil	029-871842-001	CH646	453501
Q26015	Broil	029-871842-001	CH646	453501
Q26018	Broil	029-871842-001	CH646	453501
Q26020	Broil	029-871842-001	CH646	453501
Q26085	Bake	202-871810-001	CH653	451418
Q26085	Bake	202-872878-001	CH653W	455187
Q26088	Bake	202-871810-001	CH653	451418
Q26090	Bake	202-871808-001	CH651	451400
Q26090	Bake	202-872877-001	CH651W	456171
Q26092	Bake	202-871808-001	CH651	451400
Q26092	Bake	202-872877-001	CH651W	456171
Q26093	Bake	202-871851-001	CH675	454432
Q26098	Bake	202-871808-001	CH651	451400
Q26098	Bake	202-872877-001	CH651W	456171
Q26101	Bake	202-871808-001	CH651	451400
Q26101	Bake	202-872877-001	CH651W	456171
Q26102	Bake	202-871808-001	CH651	451400
Q26102	Bake	202-872877-001	CH651W	456171
Q26105	Bake	202-871808-001	CH651	451400
Q26109	Bake	202-871807-001	CH650	451303
Q26110	Bake	202-871807-001	CH650	451303
Q26114	Bake	202-871809-001	CH652	451311
Q26115	Bake	202-871809-001	CH652	451311
Q26123	Bake	202-871810-001	CH653	451418
Q26123	Bake	202-872878-001	CH653W	455187
Q26127	Bake	202-871851-001	CH675	454432
Q26129	Bake	202-871808-001	CH651	451400
Q26129	Bake	202-872877-001	CH651W	456171
Q26131	Bake	202-871808-001	CH651	451400
Q26131	Bake	202-872877-001	CH651W	456171
Q26133	Bake	202-871810-001	CH653	451418
Q26133	Bake	202-872878-001	CH653W	455187
Q26134	Bake	202-871810-001	CH653	451418
Q26135	Bake	202-871808-001	CH651	451400
Q26135	Bake	202-872877-001	CH651W	456171
Q26136	Bake	202-871808-001	CH651	451400
Q26136	Bake	202-872877-001	CH651W	456171
Q26137	Bake	202-871851-001	CH675	454432
Q26139	Bake	202-871808-001	CH651	451400

WESTINGHOUSE (continued)

Q26139	Bake	202-872877-001	CH651W	456171
Q26140	Bake	202-871808-001	CH651	451400
Q26140	Bake	202-872877-001	CH651W	456171
Q26141	Bake	202-871808-001	CH651	451400
Q26141	Bake	202-872877-001	CH651W	456171
Q26142	Bake	202-871808-001	CH651	451400
Q26143	Bake	202-871808-001	CH651	451400
Q26143	Bake	202-872877-001	CH651W	456171
Q26144	Bake	202-871808-001	CH651	451400
Q26144	Bake	202-872877-001	CH651W	456171
Q53485	Bake	202-873843-001	CH644	454520
Q58546	Bake	202-871806-001	CH649	451506
Q58548	Bake	202-871806-001	CH649	451506
Q58626	Bake	202-871805-001	CH648	451514
Q58628	Bake	202-871805-001	CH648	451514
Q83511	Bake	202-871810-001	CH653	451418
Q83511	Bake	202-872878-001	CH653W	455187
Q83513	Bake	202-871810-001	CH653	451418
Q83513	Bake	202-872878-001	CH653W	455187
Q83516	Bake	202-871851-001	CH675	454432
Q83571	Broil	029-871842-001	CH646	453501
Q83573	Broil	029-871842-001	CH646	453501
Q83578	Broil	029-872868-001	CH2868	456198
Q83579	Broil	029-871842-001	CH646	453501
Q83580	Broil	029-871842-001	CH646	453501
Q132331	Broil	029-871844-001	CH676	453747
Q132332	Broil	029-871844-001	CH676	453747
Q132336	Broil	029-871844-001	CH676	453747
Q132562	Broil	029-871831-001	CH642	453392
Q132563	Broil	029-871831-001	CH642	453392
Q134491	Bake	202-871851-001	CH675	454432
Q134501	Bake	202-871810-001	CH653	451418
Q134501	Bake	202-872878-001	CH653W	455187
Q134502	Bake	202-871810-001	CH653	451418
Q134503	Bake	202-871810-001	CH653	451418
Q134503	Bake	202-872878-001	CH653W	455187
Q134504	Bake	202-871810-001	CH653	451418
Q134504	Bake	202-872878-001	CH653W	455187
Q138053	Broil	029-871842-001	CH646	453501
Q138063	Broil	029-871831-001	CH642	453392
Q138064	Broil	029-871831-001	CH642	453392
Q138251	Broil	029-872868-001	CH2868	456198
Q138731	Broil	202-872806-001	CH713	454660
Q138732	Broil	202-872806-001	CH713	454660
Q147361	Bake	202-871830-001	CH641	453237
Q147362	Bake	202-871830-001	CH641	453237
Q147363	Bake	202-872864-001	CH2864	455152
Q147364	Bake	202-872864-001	CH2864	455152
Q147365	Bake	202-871830-001	CH641	453237
Q147366	Bake	202-872864-001	CH2864	455152
Q147541	Bake	202-871835-001	CH645	455021
Q147542	Bake	202-871835-001	CH645	455021



Backer

Cross Reference

Bake & Broil Elements

OEM Part No.	Type	Revised Part No.	Replacement Cat. No.	PCN
--------------	------	------------------	----------------------	-----

OEM Part No.	Type	Revised Part No.	Replacement Cat. No.	PCN
--------------	------	------------------	----------------------	-----

WESTINGHOUSE (continued)

Q147545	Bake	202-871835-001	CH645	455021
Q149773	Broil	029-871831-001	CH642	453392
Q149776	Broil	029-871831-001	CH642	453392
Q149801	Broil	029-872869-001	CH2869	455099
Q149802	Broil	029-872869-001	CH2869	455099
Q149803	Broil	029-872869-001	CH2869	455099
Q207511	Bake	202-871830-001	CH641	453237
Q207512	Bake	202-872864-001	CH2864	455152
Q207513	Bake	202-872864-001	CH2864	455152
Q207516	Bake	202-872864-001	CH2864	455152
Q207517	Bake	202-871830-001	CH641	453237
Q207621	Broil	029-874897-001	CH4897	456710
Q208211	Bake	202-871835-001	CH645	455021
Q210521	Bake	202-871882-001	CH643	454070
Q210751	Broil	029-873890-001	CH677	454555
Q210781	Broil	029-872869-001	CH2869	455099
Q210782	Broil	029-872869-001	CH2869	455099
Q210811	Bake	202-871851-001	CH675	454432
Q210821	Broil	029-872868-001	CH2868	456198
Q210911	Bake	202-871810-001	CH653	451418
Q210922	Broil	029-871842-001	CH646	453501
Q210931	Broil	029-871844-001	CH676	453747
Q210941	Broil	029-871831-001	CH642	453392
Q210951	Bake	202-871807-001	CH650	451303
Q210961	Bake	202-871808-001	CH651	451400
Q210972	Bake	202-871806-001	CH649	451506
Q210981	Bake	202-871835-001	CH645	455021
Q210991	Bake	202-872806-001	CH713	454660
Q216581	Bake	202-871809-001	CH652	451311
1117906	Bake	202-871807-001	CH650	451303
1117908	Bake	202-871807-001	CH650	451303
1145452	Bake	202-871807-001	CH650	451303
1147728	Bake	202-871807-001	CH650	451303
1147730	Bake	202-871807-001	CH650	451303
1349691	Bake	202-871807-001	CH650	451303
1465524	Bake	202-871807-001	CH650	451303
1468397	Bake	202-871807-001	CH650	451303
1468398	Bake	202-871807-001	CH650	451303

WHIRLPOOL

241215	Bake	202-873823-005	CH629	453149
241472	Broil	029-873841-001	CH815	453448
245329	Bake	202-870542-002	ROP-W	400493
248216	Bake	202-874868-001	CH4868	456817
248509	Bake	202-874868-001	CH4868	456817
249613	Bake	202-874868-001	CH4868	456817
249614	Bake	202-871838-001	CH604	453106
250544	Bake	202-871838-002	CH608	454256
250545	Bake	202-874869-001	CH4869	456825
250546	Bake	202-871838-001	CH604	453106

WHIRLPOOL (continued)

255103	Bake	202-873877-001	CH687	453721
255104	Bake	202-872860-001	CH2860	454820
256844	Broil	029-873849-001	CH987	453472
257057	Bake	202-872860-001	CH2860	454820
257367	Broil	029-873849-001	CH987	453472
257368	Bake	202-872860-001	CH2860	454820
257376	Bake	202-873877-001	CH687	453721
257987	Bake	202-873877-001	CH687	453721
257988	Bake	202-872860-001	CH2860	454820
258107	Broil	029-872893-001	CH779	455996
258978	Bake	202-872860-001	CH2860	454820
261528	Bake	202-873802-001	CH528	453026
261529	Bake	202-873802-002	CH805	453350
261913	Bake	202-874878-001	CH4878	457924
261965	Broil	029-872893-001	CH779	455996
261966	Bake	202-872860-001	CH2860	454820
263035	Bake	202-871839-001	CH807	450589
265195	Bake	202-874869-001	CH4869	456825
265619	Bake	202-871804-001	CH640	454061
265620	Broil	029-873849-001	CH987	453472
265622	Broil	029-873849-001	CH987	453472
268765	Bake	202-873802-001	CH528	453026
268766	Bake	202-873802-002	CH805	453350
270400	Bake	202-873802-001	CH528	453026
270401	Bake	202-873802-002	CH805	453350
308129	Broil	029-872893-001	CH779	455996
308180	Bake	202-874836-001	CH4836	456500
311470	Bake	202-874836-001	CH4836	456500
311713	Broil	029-872893-001	CH779	455996
311714	Broil	029-872893-001	CH779	455996
311715	Broil	029-872893-001	CH779	455996
311716	Broil	029-872893-001	CH779	455996
312308	Broil	029-872893-001	CH779	455996
313827	Bake	202-874836-001	CH4836	456500
326791	Bake	202-873877-001	CH687	453721
326793	Bake	202-872860-001	CH2860	454820
326795	Broil	029-873849-001	CH987	453472
834679	Bake	202-872865-001	CH2865	455179
865940	Bake	202-872892-001	CH775	455988
865971	Bake	202-874875-001	CH4875	456737
866375	Bake	202-874879-001	CH4879	458003

WIZARD (DIXIE)

106120W	Broil	029-873883-001	CH602	454248
-	Bake	202-871803-003	CH697	454803



Backer

Cross Reference Water Heater Elements



Backer EHP

4700 John Bragg Highway

Murfreesboro, TN 37127

(615) 907-6900

<http://www.backerehp.com>



Backer

Catalog # DA-707

Cross Reference

Water Heater Elements

Type TG — 2½" Square Flange

OEM Part No.	Chromalox OEM No.	Watts	Chromalox Replacement
W. L. JACKSON			
240 Volts			
—	TG1077	750	TGA107
—	TG1107	1000	TGA110
—	TG1127	1250	TGA112
—	TG1157	1500	TGA1157
—	TG1207	2000	TGA1207
—	TG2257	2500	TGA2257
—	TG2307	3000	TGA2307
—	TG2457	4500	TGA2457
RHEEM			
240 Volts			
6614-1	TG1067	600	TGA107
6614-3	TG1077	750	TGA107
6614-5	TG1107	1000	TGA110
6614-7	TG1127	1250	TGA112
6614-9	TG1157	1500	TGA1157
6614-11	TG1207	2000	TGA1207
6614-17	TG2257	2500	TGA2257
6614-19	TG2307	3000	TGA2307
6614-21	TC2357	3500	TGA2357
6614-22	TG2407	4000	TGA2407
6614-23	TG2457	4500	TGA2457
6614-24	TG2507	5000	TGA2507
6614-25	TG2607BX	6000	TGA2607BX
120 Volts			
6614-4	TG1077	750	TGA110L
6614-6	TG1107	1000	TGA110L
6614-8	TG1127	1250	TGA112L
6614-10	TG1157	1500	TGA1157L
6614-12	TG1207	2000	TGA1207L

OEM Part No.	Chromalox OEM No.	Watts	Chromalox Replacement
A. O. SMITH			
240 Volts			
35455-0	TG1067	600	TGA107
35455-1	TG1077	750	TGA107
35455-2	TG1107	1000	TGA110
35455-3	TG1127	1250	TGA112
35455-4	TG1157	1500	TGA1157
35455-5	TG1207	2000	TGA1207
35455-6	TG2257	2500	TGA2257
35455-7	TG2307	3000	TGA2307
35455-8	TG2357	3500	TGA2357
35455-9	TG2407	4000	TGA2407
35455-10	TG2457	4500	TGA2457
35455-11	TG2507	5000	TGA2507
35455-12	TG2607BX	6000	TGA2607BX
120 Volts			
35454-0	TG1067	600	TGA110L
35454-1	TG1077	750	TGA110L
35454-2	TG1107	1000	TGA110L
35454-3	TG1127	1250	TGA112L
35454-4	TG1157	1500	TGA1157L
35454-5	TG2257	2000	TGA1207L
35454-6	TG2257	2500	TGA2257L
35454-7	TG2307	3000	TG2307
TENNESSEE TANK — MOR FLO			
240 Volts			
—	TG1067	600	TGA107
—	TG1077	750	TGA107
—	TG1107	1000	TGA110
—	TG1127	1250	TGA112
—	TG1157	1500	TGA1157
—	TG1207	2000	TGA1207
—	TG2257	2500	TGA2257
—	TG2307	3000	TGA2307
—	TG2357	3500	TGA2357
—	TG2407	4000	TGA2407
—	TG2457	4500	TGA2457
—	TG2507	5000	TGA2507
—	TG2557X1	5500	TG2557X1
—	TG2607	6000	TG2607

Type SG — 1" Screw Plug

OEM Part No.	Chromalox OEM No.	Watts	Chromalox Replacement
RHEEM			
240 Volts			
7485BL	SG1067	600	AH1707
7485CL	SG1077	750	AH1707
7485DL	SG1107	1000	AH1710
7485EL	SG1127	1250	AH1712
7485FL	SG1157	1500	AH1715
7485GL	SG1207	2000	AH1720
7485HL	SG2257	2500	AH2725
7485JL	SG2307	3000	AH2730
7485KL	SG2357X1	3500	SG2357X1
7485LL	SG2407X1	4000	SG2407X1
7485ML	SG2457	4500	AH2745

OEM Part No.	Chromalox OEM No.	Watts	Chromalox Replacement
120 Volts			
7483BL	SG1067	600	AL1707
7483CL	SG1077	750	AL1707
7483DL	SG1107	1000	AL1710
7483EL	SG1127	1250	AL1712
7483FL	SG1157	1500	AL1715
7483GL	SG1207	2000	AL1207
7483KL	SG1177X1	1700	
120 Volts — High Watt Density			
7483EH	SG1123	1250	SG1123
7483FH	SG1153	1500	SG1153
7483GH	SG1203	2000	SG1203
7483HH	SG1253	2500	SG1253
7483JH	SG1303	3000	SG1303



Backer

Cross Reference Water Heater Elements

Type SG – 1" Screw Plug (continued)

OEM Part No.	Chromalox OEM No.	Watts	Chromalox Replacement
A. O. SMITH			
240 Volts			
23791-2	SG1107	1000	AH1710
23791-4	SG1157	1500	AH1715
23791-5	SG1207	2000	AH1720
23791-6	SG2257	2500	AH2725
23791-7	SG2307	3000	AH2730
23791-8	SG2357	3500	AH2735
23791-9	SG2407	4000	AH2740
23791-10	SG2457	4500	AH2745
23791-11	SG2507	5000	AH2750
23791-12	SG2607X1	6000	SG2607X1
23791-14	SG2557	5500	AH2755

OEM Part No.	Chromalox OEM No.	Watts	Chromalox Replacement
WESTINGHOUSE			
240 Volts			
C82607	SG1067	600	AH1707
C82608	SG1077	750	AH1707
C82609	SG1107	1000	AH1710
C82610	SG1127	1250	AH1712
C82611	SG1157	1500	AH1715
C82612	SG1207	2000	AH1720
C82613	SG2257	2500	AH2725
C82614	SG2307	3000	AH2730
C82615	SG2357	3500	AH2735
C82616	SG2407	4000	AH2740
C82617	SG2457	4500	AH2745
C82618	SG2507X1	5000	SG2507X1
120 Volts			
C82592	SG1067	600	AL1707
C82594	SG1107	1000	AL1710
C82595	SG1127	1250	AL1712
C82596	SG1157	1500	AL1715

Type LS – Round Flange

OEM Part No.	Chromalox OEM No.	Watts	Chromalox Replacement
STATE STOVE			
240 Volts			
—	LS1067	600	RLS1107H
—	LS1077	750	RLS1107H
—	LS1107	1000	RLS1107H
240 Volts — High Watt Density			
—	LS1123	1250	LS1123
—	LS1153	1500	LS1153
—	LS1203	2000	LS1203
—	LS1253	2500	LS1253
—	LS1303	3000	LS1303
—	LS1353	3500	LS1353
—	LS1403	4000	LS1403
—	LS1453	4500	LS1453
—	LS2503	5000	LS2503
—	LS2553	5500	LS2553
—	LS2603	6000	LS2603
120 Volts — High Watt Density			
—	LS1163	1650	LS1163



Backer

Cross Reference Special Purpose Elements



Backer EHP

4700 John Bragg Highway

Murfreesboro, TN 37127

(615) 907-6900

<http://www.backerehp.com>



Backer

Catalog # DA-707

Cross Reference Special Purpose Elements

OEM Part No	Type	Revised Part No.	Replacement Cat. No.	PCN
-------------	------	------------------	----------------------	-----

GRILL ELEMENTS

ROPER

111214	Plug-in	415-874819-001	CH4819	457510
291213	Plug-in	415-874820-001	CH4820	457641
310604	Plug-in	415-874817-001	CH4817	456450
322635	Plug-in	415-874818-001	CH4818	458062
329023	Flat Pin	415-876812-001	CH6812	440268
329199	Flat Pin	415-876815-001	CH6815	440292
330311	Round Pin	415-876814-001	CH6814	440284
330312	Round Pin	415-876817-001	CH6817	440313
330313	Flat Pin	415-876809-001	CH6809	440233
330314	Flat Pin	415-876815-001	CH6815	440292
330315	Round Pin	415-876811-001	CH6811	440250
330316	Round Pin	415-876817-001	CH6817	440313
331427	Flat Pin	415-876809-001	CH6809	440233
331428	Flat Pin	415-876815-001	CH6815	440292
333177	Flat Pin	415-876812-001	CH6812	440268
333178	Flat Pin	415-876815-001	CH6815	440292
333590	Flat Pin	415-876813-001	CH6813	440276
333864	Flat Pin	415-876816-001	CH6816	440305
334737	Round Pin	415-876817-001	CH6817	440313
334979	Flat Pin	415-876815-001	CH6815	440292
334980	Flat Pin	415-876809-001	CH6809	440233
334981	Flat Pin	415-876812-001	CH6812	440268
334999	Round Pin	415-876814-001	CH6814	440284
335000	Round Pin	415-876811-001	CH6811	440250
335001	Flat Pin	415-876813-001	CH6813	440276
335002	Flat Pin	415-876816-001	CH6816	440305
335766	Round Pin	415-876810-001	CH6810	440241

THERMADOR

14-39-160	Plug-in	415-876805-001	CH6805	440196
14-39-161	Plug-in	415-876805-001	CH6805	440196
14-39-162	Plug-in	415-876805-001	CH6805	440196
20-09-161	Plug-in	415-876806-001	CH6806	440209

WHIRLPOOL/KITCHEN AID/CHAMBERS

D307047-1	Plug-in	415-876807-001	CH6807	440217
D307047-2	Plug-in	415-876807-001	CH6807	440217
307672-1	Plug-in	415-876808-001	CH6808	440225
WW3177251-3	Plug-in	415-876807-001	CH6807	440217

OEM Part No	Type	Revised Part No	Replacement Cat No	PCN
-------------	------	-----------------	--------------------	-----

CEILING HEATER ELEMENTS

BROAN

99-27-0039	Perm. Mount	319-875800-001	CH137	456630
------------	-------------	----------------	-------	--------

EMERSON-PRYNE

1802015	Perm. Mount	319-873898-001	CH148	453974
---------	-------------	----------------	-------	--------

FASCO

657-21	Perm. Mount	319-875807-001	CH155	456702
--------	-------------	----------------	-------	--------

MARKEL

A-698	Perm. Mount	319-875805-001	CH152	456681
A-699	Perm. Mount	319-875805-001	CH152	456681
A-781	Perm. Mount	319-875801-001	CH138	456649
A-783	Perm. Mount	319-875801-001	CH138	456649

NUTONE

C-10593	Perm. Mount	319-875804-001	CH149	456673
C-15928	Perm. Mount	319-873897-001	CH136	453940
C-16476	Perm. Mount	319-875804-001	CH149	456673
C-18041	Perm. Mount	319-875802-001	CH141	456657
C-21356	Perm. Mount	319-875802-001	CH141	456657
C-23253	Perm. Mount	319-875803-001	CH143	456665
C-23254	Perm. Mount	319-875802-001	CH141	456657
C-26718	Perm. Mount	319-875803-001	CH143	456665
—	Perm. Mount	319-875806-001	CH154	456690



Backer

Cross Reference Special Purpose Elements

OEM Part No.	Type	Revised Part No.	Replacement Cat. No.	PCN
--------------	------	------------------	----------------------	-----

REFRIGERATOR-DEFROSTER ELEMENTS

GIBSON

162432-2	Perm. Mount	087-874131-003	CH419	458759
----------	-------------	----------------	-------	--------

PHILCO

649-099-1K	Perm. Mount	087-875181-001	CH415	458740
------------	-------------	----------------	-------	--------

WHIRLPOOL

530322	Perm. Mount	087-874802-001	CH4802	455216
547882	Perm. Mount	087-874801-001	CH4801	455208
934445	Perm. Mount	087-873442-006	CH431	458775
935798	Perm. Mount	087-874651-002	CH434	458804
937302	Perm. Mount	087-874490-010	CH433	458791
978331	Perm. Mount	087-873467-005	CH413	458724
978332	Perm. Mount	087-873467-006	CH414	458732
978495	Perm. Mount	087-873030-003	CH429	458767
989612	Perm. Mount	087-874490-009	CH432	458783

DISHWASHER ELEMENTS

COLUMBUS PRODUCTS

2646D86A03	Perm. Mount	393-876818-001	CH6818	440321
S443401	Perm. Mount	157-876819-001	CH6819	440330

D&M CORP.

93277	Perm. Mount	157-876821-001	CH6821	440356
93358	Perm. Mount	157-876822-001	CH6822	440364

HOBART

800099	Perm. Mount	157-876820-001	CH6820	440348
--------	-------------	----------------	--------	--------

WHIRLPOOL

719687	Perm. Mount	157-876823-001	CH6823	440372
--------	-------------	----------------	--------	--------

MANY MANUFACTURERS

89638-1E	Perm. Mount	157-874804-001	CH4804	456606
----------	-------------	----------------	--------	--------



Backer

A World Of Warmth

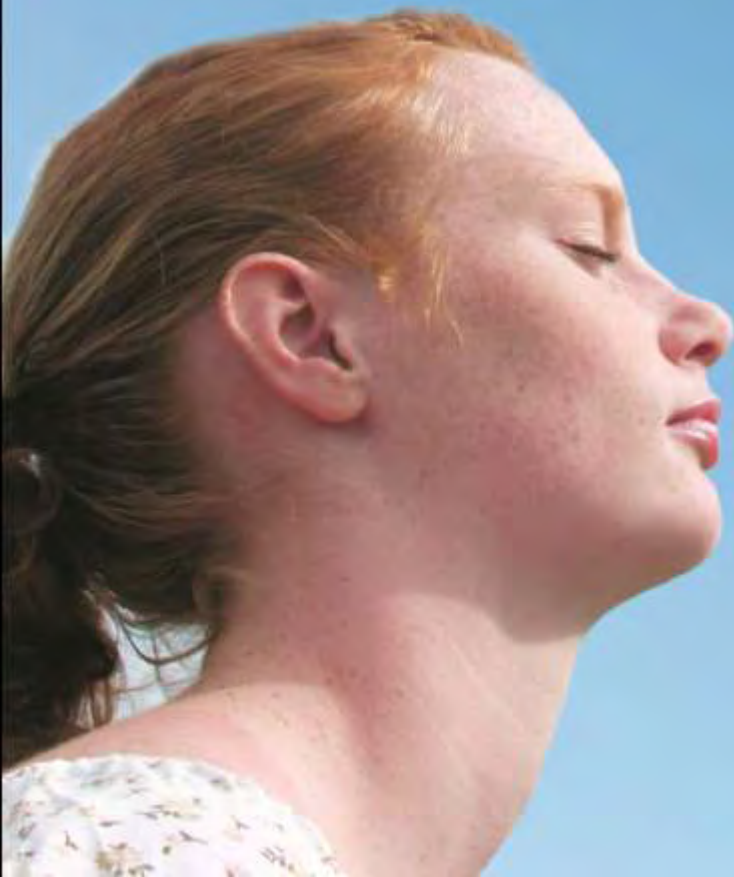

Backer EHP

4700 John Bragg Highway
Murfreesboro, TN 37127
(615) 907-6900
<http://www.backerehp.com>



Backer